

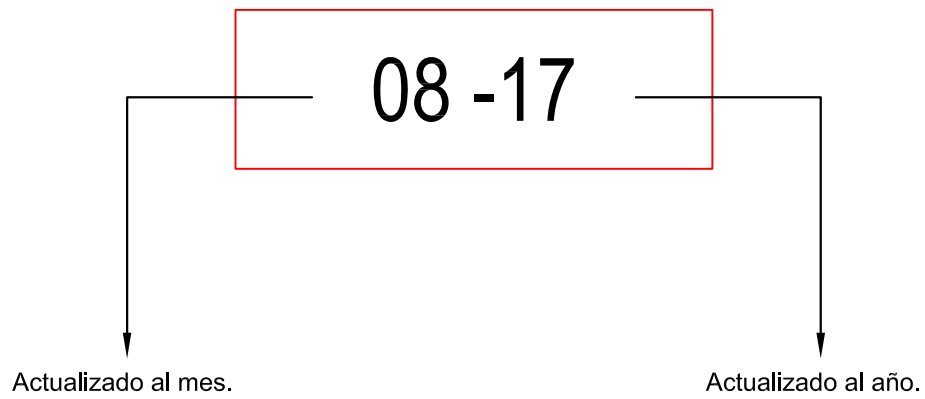

# *SISTEMAS COMPLEMENTARIOS*



Todos los pesos indicados son estimados de acuerdo a la dimensión nominal del perfil y sus posibles variaciones en el peso, son el resultado de aplicar las tolerancias dimensionales según Norma IRAM 699. La empresa se reserva el derecho de modificar total o parcialmente, sin previo aviso, las especificaciones contenidas en este catálogo.



INDICE	PÁG.
Listado de perfiles	04
Perfiles para frente de vidriera	08
Perfiles de revestimiento	09
Perfiles de parasol	10
Perfiles para mampara de baño	11
Perfiles para tabiquería tubular	12
Perfiles para cortina	15
Perfiles para accesorios	18
Perfiles varios	22
Parasol regulable - Detalles	23
Parasol fijo - Detalles	24
Mampara de baño corrediza - Vistas, descuentos y detalles	25
Mampara de baño rebatible - Vistas, descuentos y detalles	26
Tabique tubular curvo liviano - Detalles	27
Tabique tubular recto - Detalles	30
Cortina "Barrio modelo 1" - Vistas y descuentos	32
Cortina "Barrio modelo 1" - Accesorios	33
Cortina "Barrio modelo 2" - Vistas y descuentos	34
Cortina "Barrio modelo 2" - Accesorios	35
Cortina "Barrio modelo 1 y 2" - Detalles	36
Cortina "común" - Vistas	38
Cortina "común" - Detalles	39
Generalidades	40



## Listado de Perfiles

CÓDIGO	PESO (kg/m)	DESCRIPCIÓN	FORMA	PÁG.
MI-0099	0.610	Escuadra para premarco		18
MI-0100	0.543	Escuadra para premarco		18
MI-0135	0.424	Presilla de hoja fija PRE-950		19
MI-0137	0.456	Presilla para hoja fija PRE-951		19
MI-0138	0.486	Soporte para MT127		19
MT-0036	0.772	Tablilla parasol móvil		10
MT-0169	0.386	Umbral cubre bañera		11
MT-0188	0.551	Marco cubre duchador		11
MT-0189	0.235	Tapa de zócalo tabiquería tubular		14
MT-0190	0.996	Zócalo tabiquería tubular		14
MT-0191	0.176	Complemento		14
MT-0192	0.111	Contra vidrio corto		14
MT-0193	0.135	Contra vidrio tabiquería tubular		14
MT-0194	0.459	Travesaño tabiquería tubular		14
MT-0195	0.640	Columna tabiquería tubular		14
MT-0243	0.545	Guía cortina común Actual		17
MT-0244	0.896	Guía de cortina barrio Actual		17
MT-0479	0.489	"U" de armado		21
MT-0650	0.780	Parasol fijo		10
MT-0700	1.242	Travesaño tubular paño fijo		08
MT-0711	1.102	Paño fijo tubular (90x40 mm)		08
MT-0802	0.302	Tablilla celosía		22
MT-0807	0.945	Tablilla tablero		09
MT-0830	0.346	Hoja de mampara de baño		11



## Listado de Perfiles

CÓDIGO	PESO (kg/m)	DESCRIPCIÓN	FORMA	PÁG.
MT-0836	0.548	Escuadra universal liviana		18
MT-0837	0.724	Escuadra universal		18
MT-0843	0.610	Bisagra		19
MT-0844	0.818	Bisagra		19
MT-0890	0.680	Columna		13
MT-0891	0.416	Tapa columna		13
MT-0892	0.548	Travesaño		13
MT-0893	0.513	Marco puerta tabique		12
MT-0894	0.189	Tapa		12
MT-0895	0.197	Porta vidrio		13
MT-0898	0.319	Tapa zócalo		12
MT-0899	0.988	Zócalo		12
MT-0920	0.419	Guía cortina común Clásica		17
MT-0991	0.424	Tablilla de cortina		16
MT-0992	0.635	Revestimiento doble faz		09
MT-0993	0.564	Revestimiento bajo relieve		09
MT-0995	0.932	Revestimiento 7 mm		09
MT-1003	0.108	Perfil J 7 x 25 mm		22
MT-1012	0.761	Umbral vitrina		22
MT-1041	0.292	Varios		22
MT-1089	0.184	Riel vitrina		22
MT-1127	0.605	Bisagra		19
MT-1148	0.737	Guía de cortina barrio Clásica		17
MT-1267	0.510	Tablilla cortina regulable		16











## Listado de Perfiles

CÓDIGO	PESO (kg/m)	DESCRIPCIÓN	FORMA	PÁG.
MT-1345	0.770	Cabezal cubre bañera		11
MT-1346	0.305	Travesaño intermedio hoja cubre bañera		11
MT-1347	0.267	Barral cubre bañera		11
MT-1349	0.348	Umbral sanitario cubre bañera		11
MT-1350	0.292	Jamba cubre bañera		11
MT-1391	0.726	Columna tabique divisorio		12
MT-1392	0.537	Tapa columna tabique divisorio		13
MT-1393	0.616	Parante 50 mm		13
MT-1395	0.440	Dintel tabique divisorio		12
MT-1396	0.216	Tapa dintel tabique divisorio		13
MT-1427	0.521	Tablilla de revestimiento		09
MT-1674	0.184	Dintel vitrina		22
MT-1952	0.321	Porta rueda cubre bañera		19
MT-1982	0.554	Zócalo de cortina		16
MT-2457	1.094	"U" de armado		21
MT-2684	0.877	Tablilla parasol móvil		10
MT-2700	0.894	Zócalo cortina regulable		15
MT-2701	0.475	Primera tablilla cortina regulable		15
MT-2702	0.481	Tablilla cortina regulable		15
MT-2789	0.921	Zócalo		12
MT-2790	0.232	Tapa zócalo pasa cables		12
MT-2852	0.643	Zócalo cortina de enrollar		16
MT-2853	0.532	Tablilla cortina de enrollar		16
MT-2924	0.929	Guía techo corredizo		22



## Listado de Perfiles

CÓDIGO	PESO (kg/m)	DESCRIPCIÓN	FORMA	PÁG.
MT-4029	0.713	Guía de cortina barrio MASS R60		17
MT-5137	4.339	Anclaje de columna ANC 951		20
MT-5253	2.633	Presilla de cieloraso PRE 954		20
MT-5400	0.732	Presilla de revestimiento PRE 953		21
MT-5401	1.061	Empalme de columna LUV 974		21
MT-5605	2.087	Anclaje inferior de columna ANC 964/966		21
MT-5615	0.359	Cuña para escuadra CON-405/403		18
MT-5616	1.056	Cuerpo de escuadra CON-405/403		18

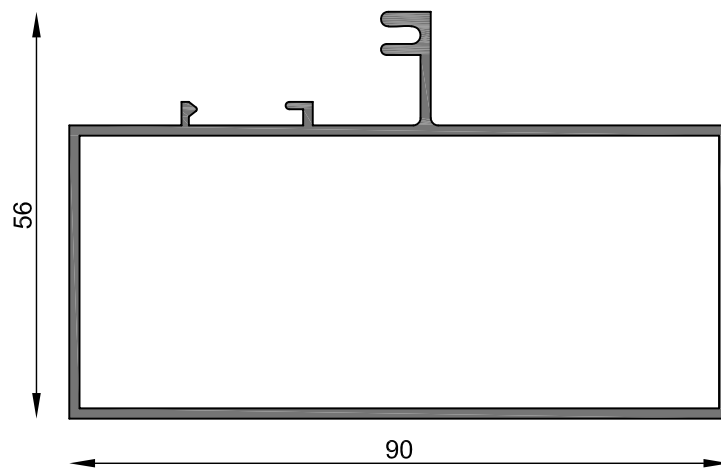

MT-0711  
Paño fijo tubular (90 x 40 mm)  
Peso estimado: 1.102 Kg/m  
Largo STD: 6150 mm

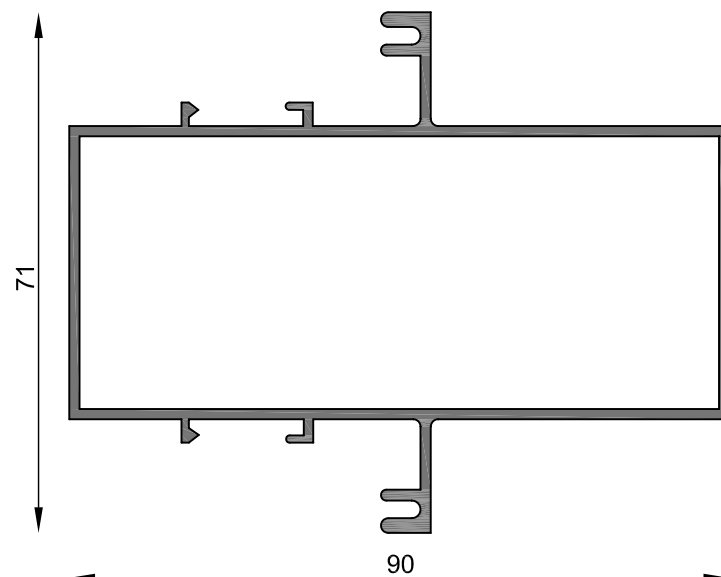

MT-0700  
Travesaño tubular paño fijo  
Peso estimado: 1.242 Kg/m  
Largo STD: 6030 mm

Esc 1:1



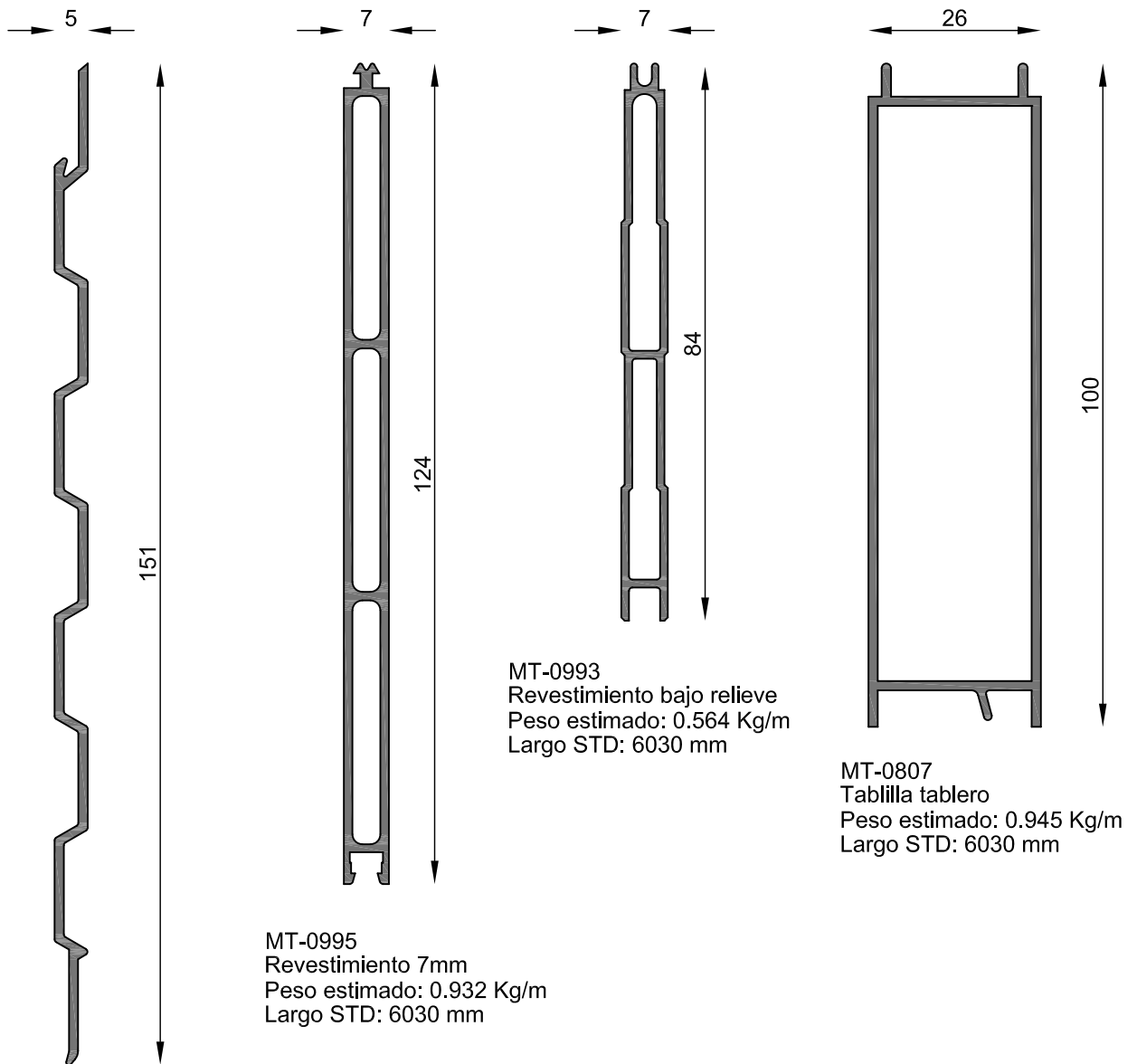

MT-0992  
Revestimiento doble Faz  
Peso estimado: 0.635 Kg/m  
Largo STD: 6030 mm

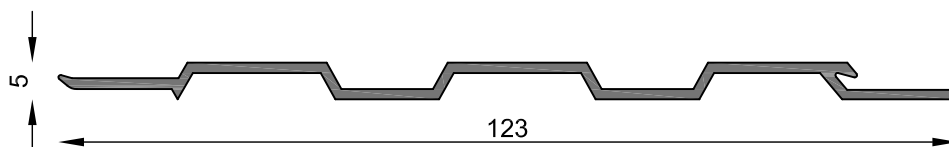

MT-1427  
Tablilla revestimiento  
Peso estimado: 0.521 Kg/m  
Largo STD: 6030 mm

Esc 1:1

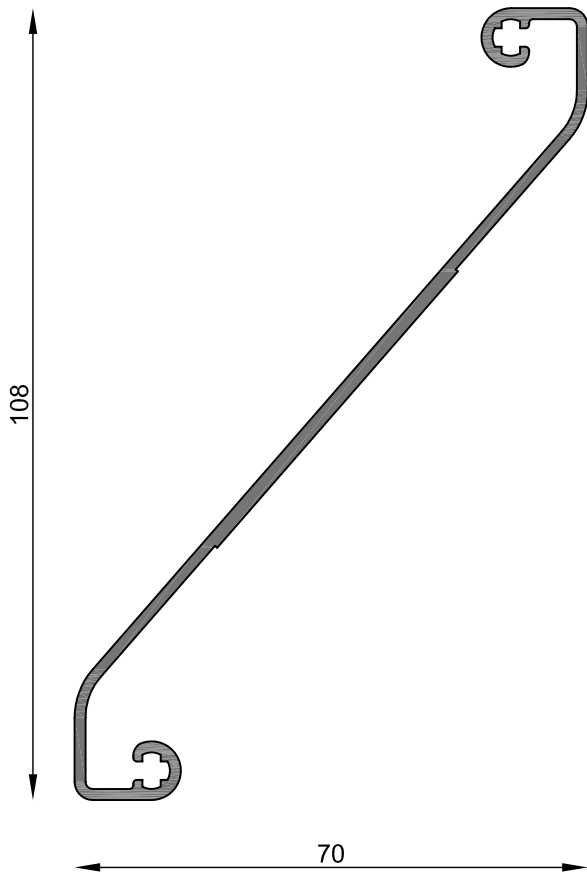

MT-0650  
Parasol fijo  
Peso estimado: 0.780 Kg/m  
Largo STD: 6030 mm

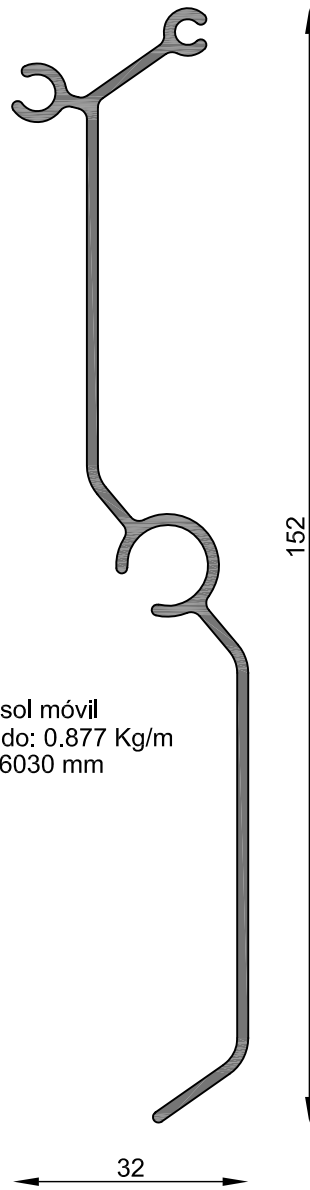

MT-2684  
Tablilla parasol móvil  
Peso estimado: 0.877 Kg/m  
Largo STD: 6030 mm

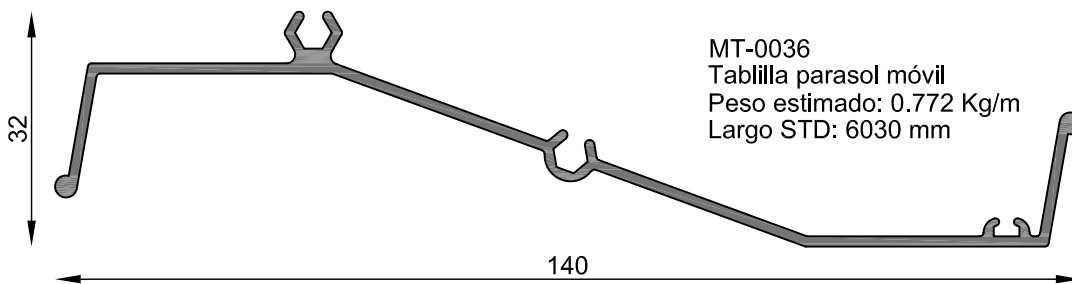

MT-0036  
Tablilla parasol móvil  
Peso estimado: 0.772 Kg/m  
Largo STD: 6030 mm

Esc 1:1

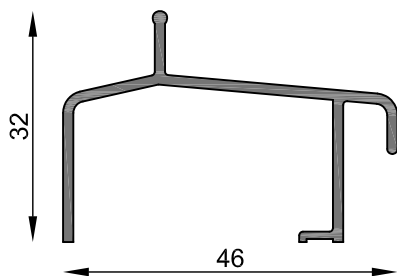

MT-0169  
Umbral cubre bañera  
Peso estimado: 0.386 Kg/m  
Largo STD: 6030 mm

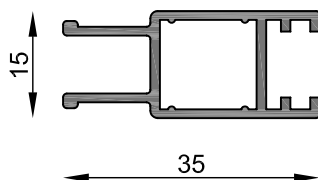

MT-0830  
Hoja de mampara de baño  
Peso estimado: 0.346 Kg/m  
Largo STD: 6030 mm

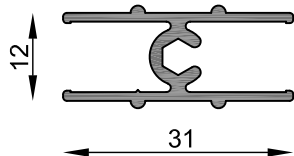

MT-1346  
Travesaño intermedio hoja cubre bañera  
Peso estimado: 0.305 Kg/m  
Largo STD: 6030 mm

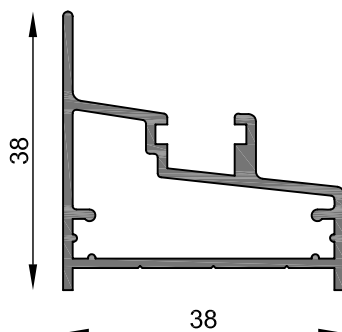

MT-0188  
Marco cubre duchador  
Peso estimado: 0.551 Kg/m  
Largo STD: 6150 mm

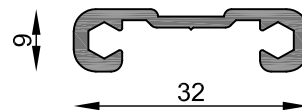

MT-1347  
Barral cubre bañera  
Peso estimado: 0.267 Kg/m  
Largo STD: 6030 mm

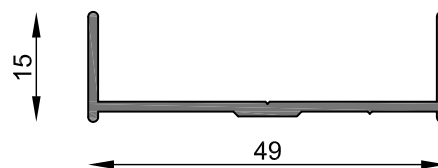

MT-1350  
Jamba cubre bañera  
Peso estimado: 0.292 Kg/m  
Largo STD: 6030 mm

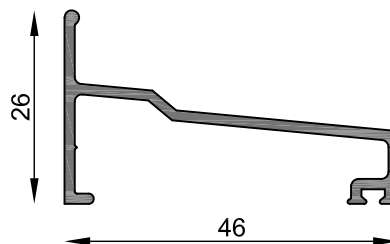

MT-1349  
Umbral sanitario cubre bañera  
Peso estimado: 0.348 Kg/m  
Largo STD: 6030 mm

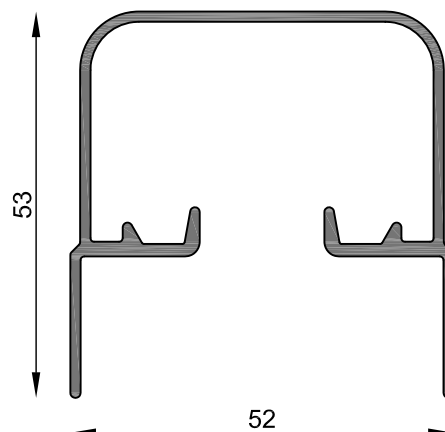

MT-1345  
Cabezal cubre bañera  
Peso estimado: 0.770 Kg/m  
Largo STD: 6030 mm

Esc 1:1

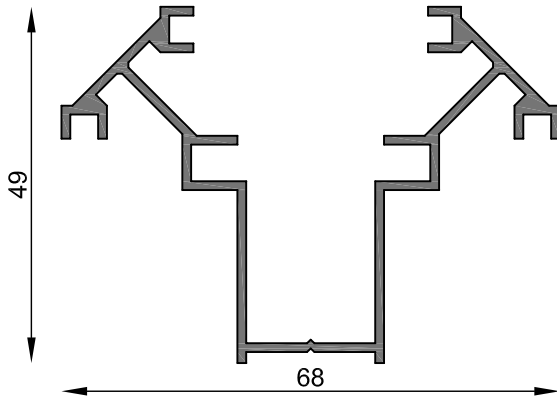

MT-1391  
Columna tabique divisorio  
Peso estimado: 0.726 Kg/m  
Largo STD: 6030 mm

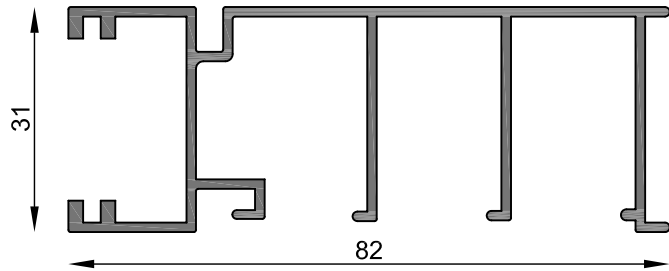

MT-2789  
Zócalo  
Peso estimado: 0.921 Kg/m  
Largo STD: 6030 mm

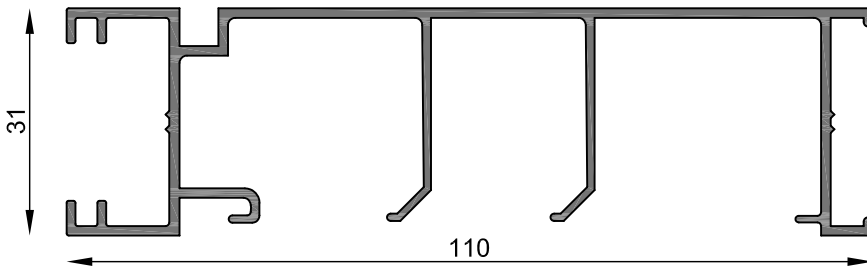

MT-0899  
Zócalo  
Peso estimado: 0.988 Kg/m  
Largo STD: 6030 mm

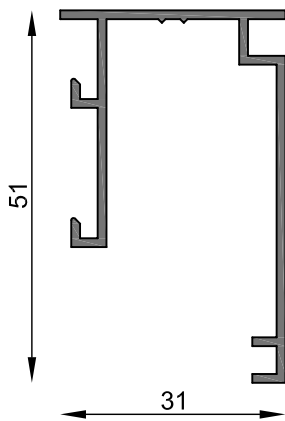

MT-1395  
Dintel tabique divisorio  
Peso estimado: 0.440 Kg/m  
Largo STD: 6030 mm

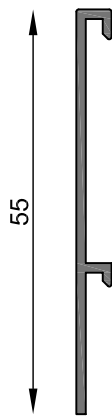

MT-0898  
Tapa zócalo  
Peso estimado: 0.319 Kg/m  
Largo STD: 6030 mm

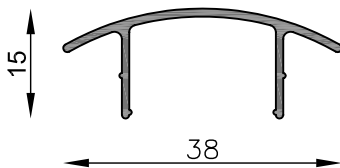

MT-0894  
Tapa  
Peso estimado: 0.189 Kg/m  
Largo STD: 6030 mm

MT-2790  
Tapa zócalo pasa cables  
Peso estimado: 0.232 Kg/m  
Largo STD: 6030 mm

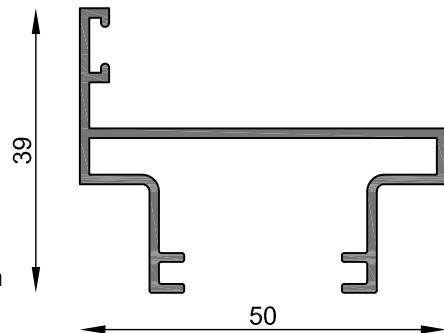

MT-0893  
Marco puerta tabique  
Peso estimado: 0.513 Kg/m  
Largo STD: 6150 mm

Esc 1:1

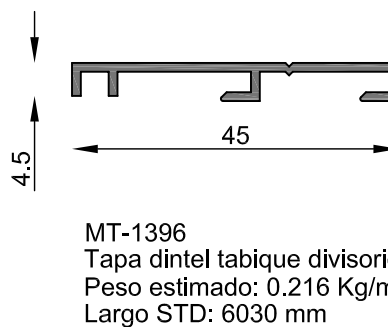
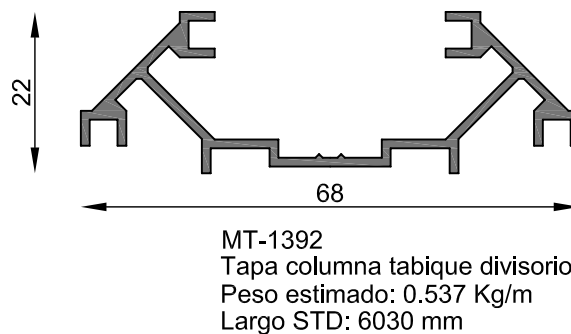
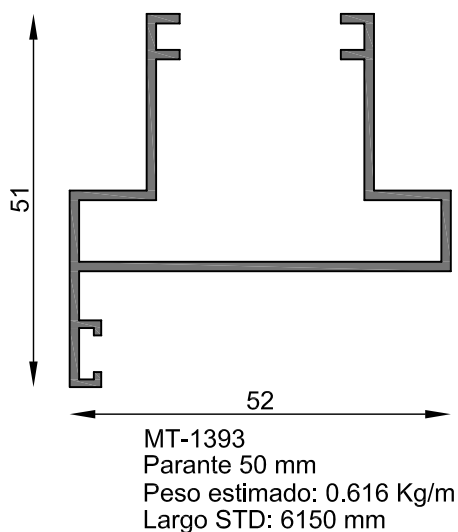
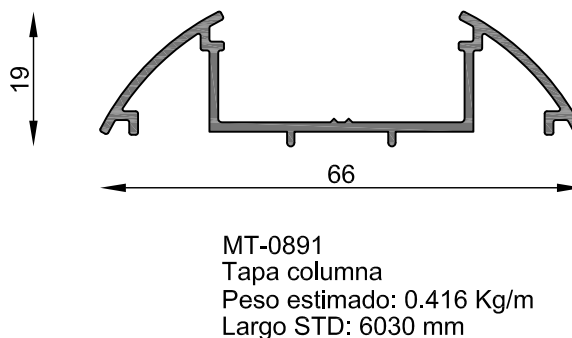
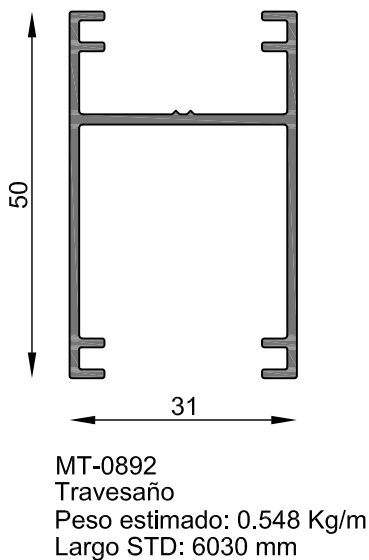
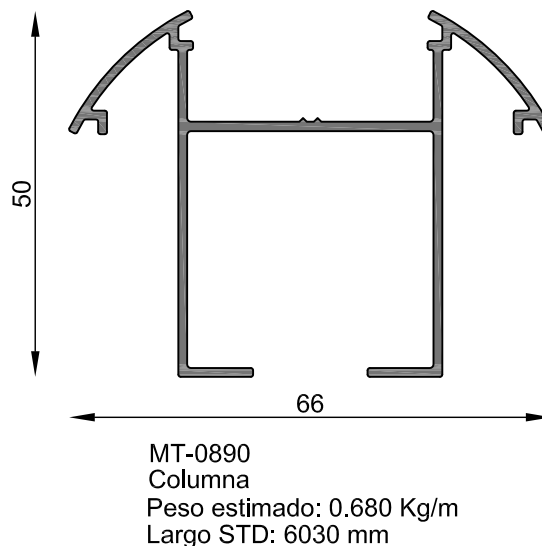
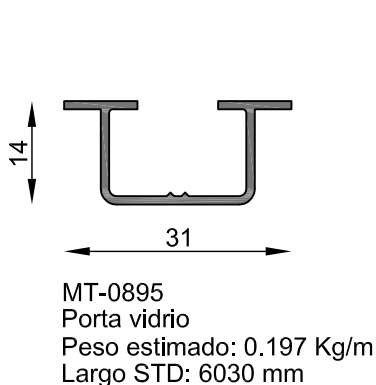

Esc 1:1

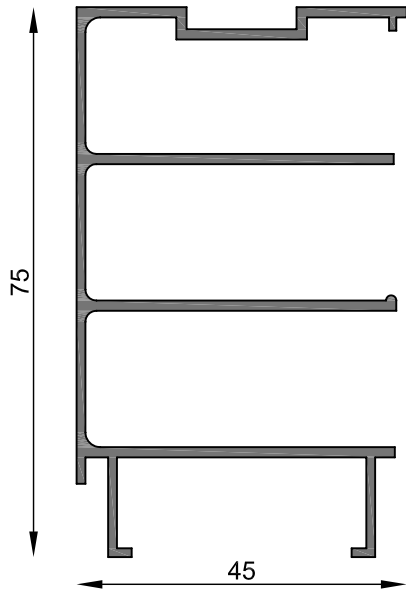

MT-0190  
Zócalo tabiquería tubular  
Peso estimado: 0.996 Kg/m  
Largo STD: 6030 mm

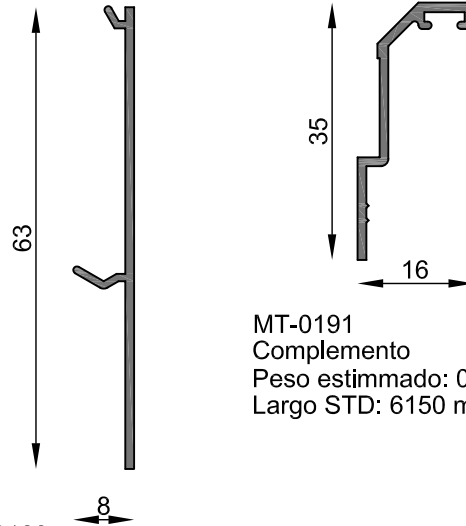

MT-0189  
Tapa de zócalo Tabiquería tubular  
Peso estimado: 0.235 Kg/m  
Largo STD: 6030 mm

MT-0191  
Complemento  
Peso estimado: 0.176 Kg/m  
Largo STD: 6150 mm

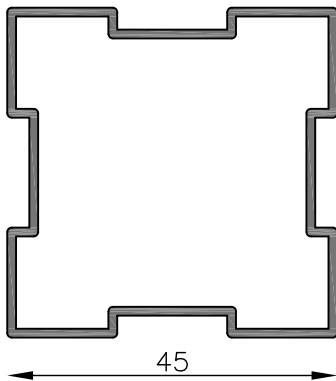

MT-0195  
Columna tabiquería tubular  
Peso estimado: 0.640 Kg/m  
Largo STD: 6030 mm

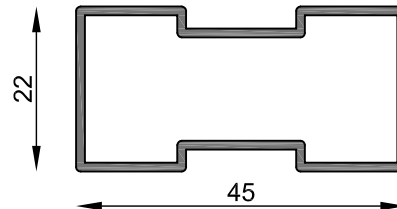

MT-0194  
Travesaño tabiquería tubular  
Peso estimado: 0.459 Kg/m  
Largo STD: 6030 mm

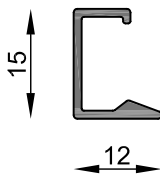

MT-0192  
Contravidrio corto  
Peso estimado: 0.111 Kg/m  
Largo STD: 6030 mm

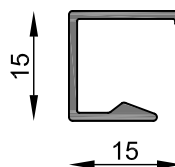

MT-0193  
Contravidrio tabiquería tubular  
Peso estimado: 0.135 Kg/m  
Largo STD: 6030 mm

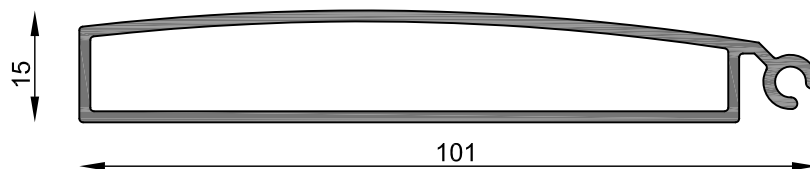

MT-2700  
Zócalo cortina regulable  
Peso estimado: 0.894 Kg/m  
Largo STD: 6030 mm

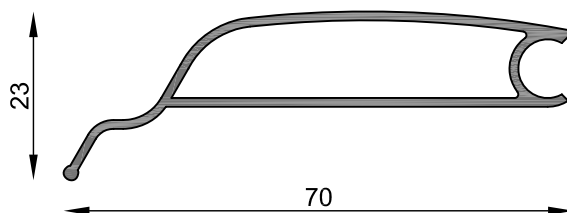

MT-2701  
Primera tablilla cortina regulable  
Peso estimado: 0.475 Kg/m  
Largo STD: 6030 mm

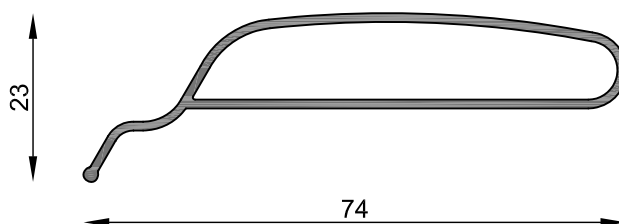

MT-2702  
Tablilla cortina regulable  
Peso estimado: 0.481 Kg/m  
Largo STD: 6030 mm

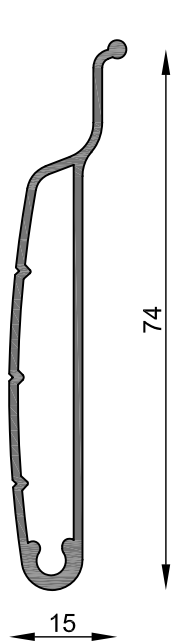

MT-1267  
 Tablilla cortina regulable  
 Peso estimado: 0.510 Kg/m  
 Largo STD: 6030 mm

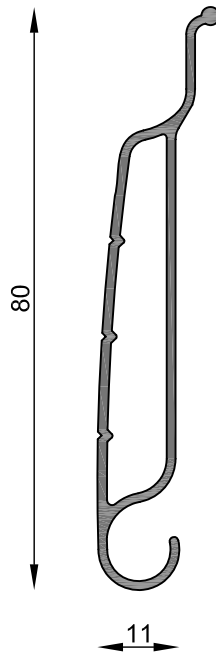

MT-2853  
 Tablilla cortina de enrollar  
 Peso estimado: 0.532 Kg/m  
 Largo STD: 6030 mm

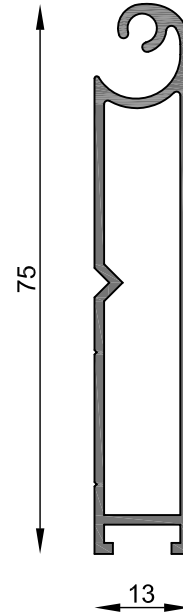

MT-2852  
 Zocalo cortina de enrollar  
 Peso estimado: 0.643 Kg/m  
 Largo STD: 6030 mm

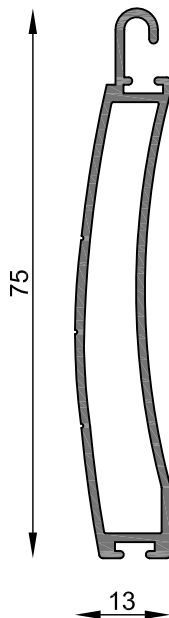

MT-1982  
 Zócalo de cortina  
 Peso estimado: 0.554 Kg/m  
 Largo STD: 6030 mm

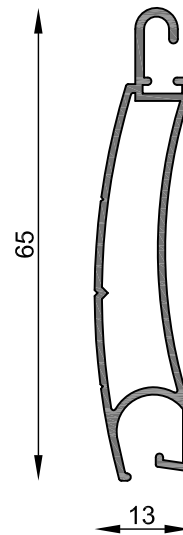

MT-0991  
 Tablilla de Cortina  
 Peso estimado: 0.424 Kg/m  
 Largo STD: 6030 mm

Esc 1:1



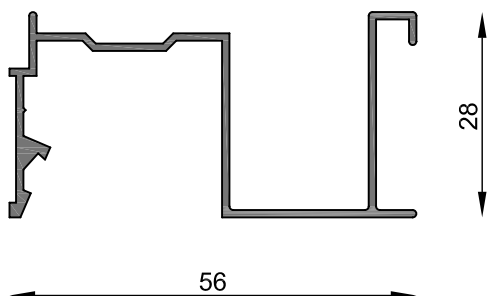
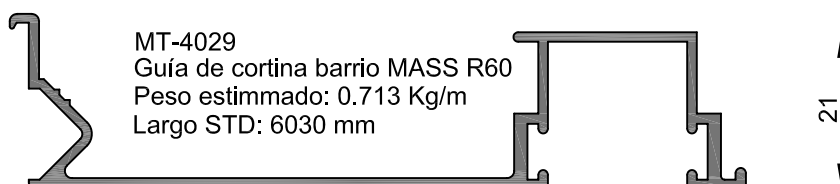
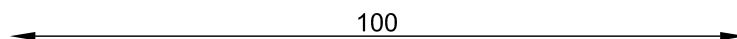
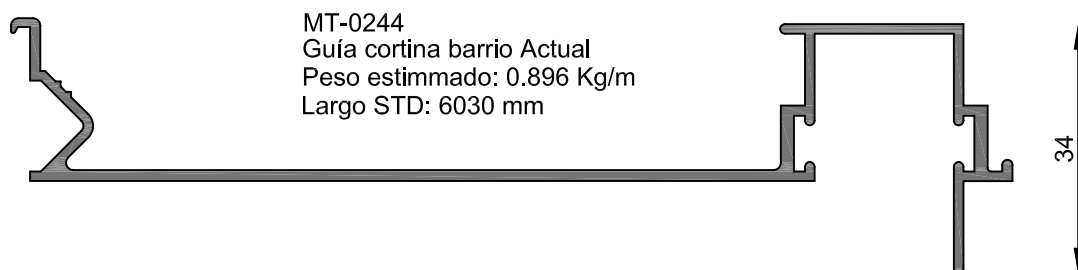
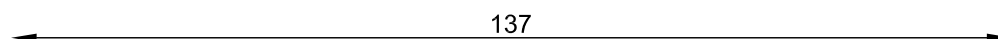
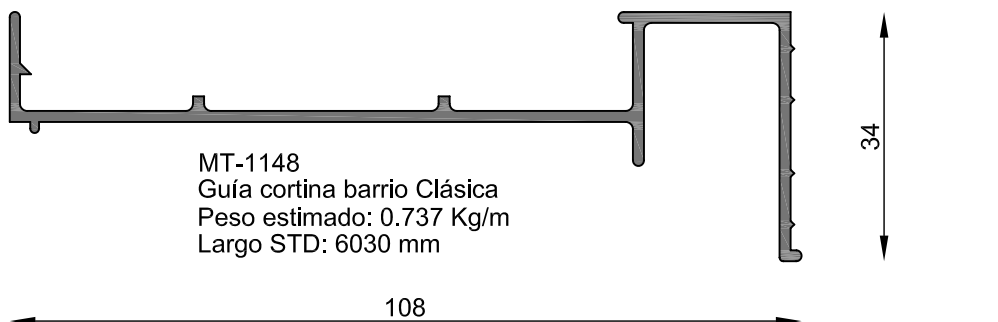

MT-0920  
 Guía cortina común Clásica  
 Peso estimado: 0.419 Kg/m  
 Largo STD: 6030 mm

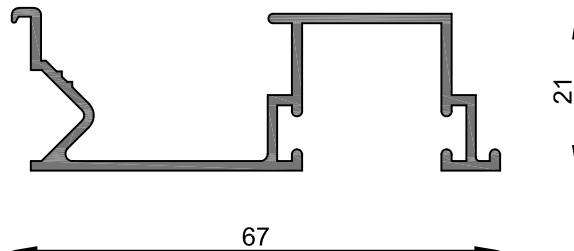

MT-0243  
 Guía cortina común Actual  
 Peso estimado: 0.545 Kg/m  
 Largo STD: 6030 mm

Esc 1:1

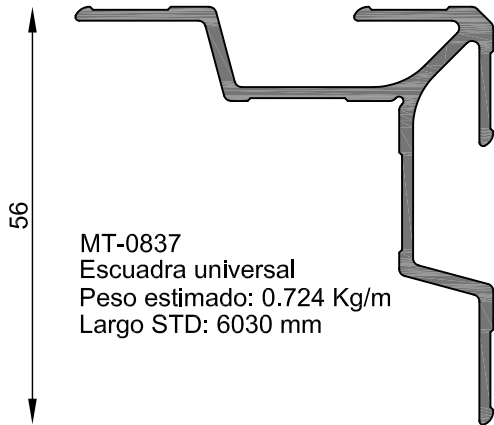

MT-0837  
Escuadra universal  
Peso estimado: 0.724 Kg/m  
Largo STD: 6030 mm

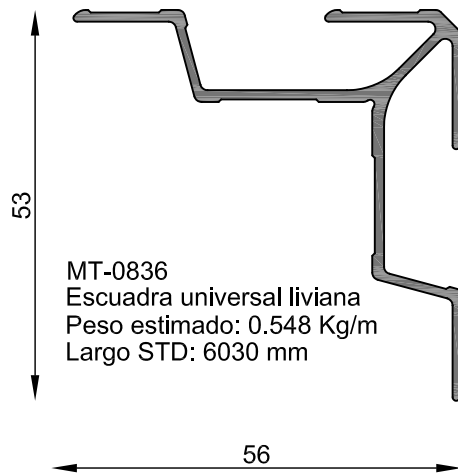

MT-0836  
Escuadra universal liviana  
Peso estimado: 0.548 Kg/m  
Largo STD: 6030 mm

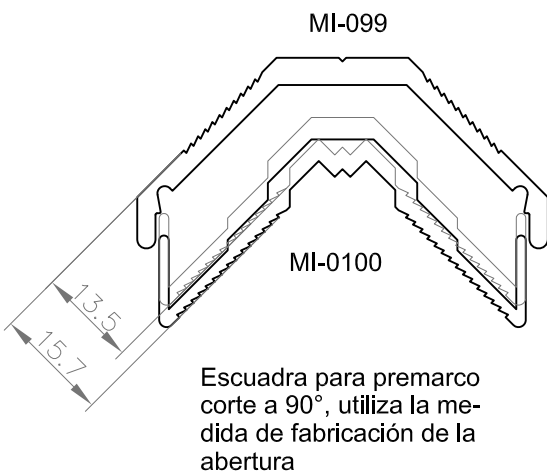

Escuadra para premarco  
corte a 90°, utiliza la medida de fabricación de la abertura



MI-099  
Escuadra para premarco  
Peso estimado: 0.610 Kg/m  
Largo STD: 6030 mm

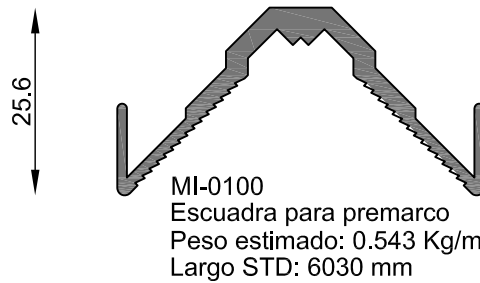

MI-0100  
Escuadra para premarco  
Peso estimado: 0.543 Kg/m  
Largo STD: 6030 mm

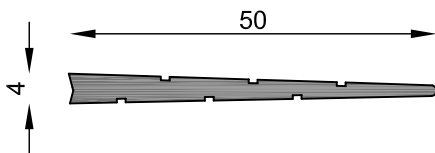

MT-5615  
Cuña para escuadra CON-405/403  
Peso estimado: 0.359 Kg/m  
Largo STD: 6030 mm

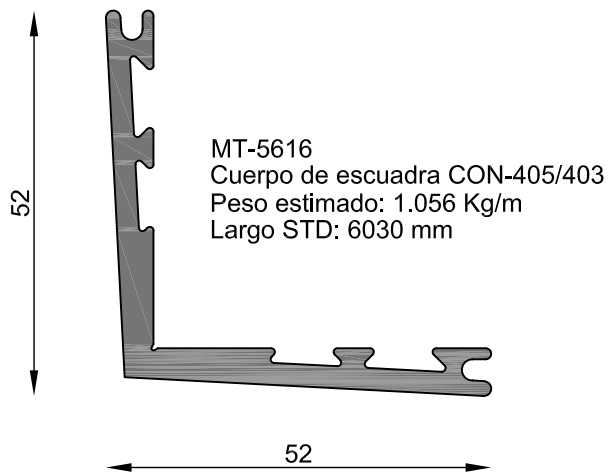

MT-5616  
Cuerpo de escuadra CON-405/403  
Peso estimado: 1.056 Kg/m  
Largo STD: 6030 mm

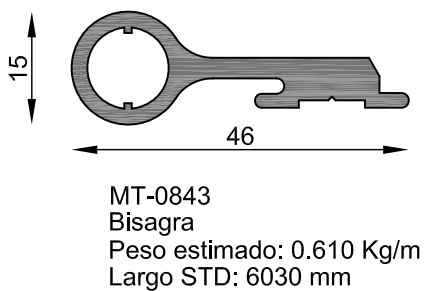
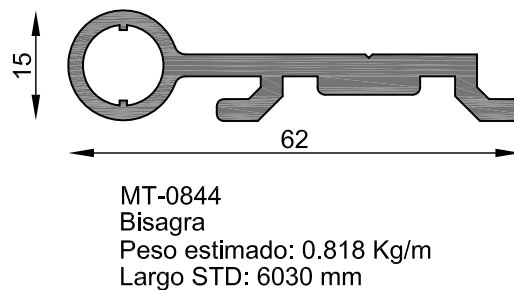
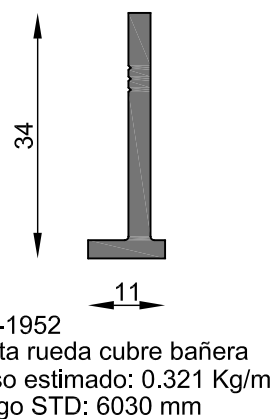
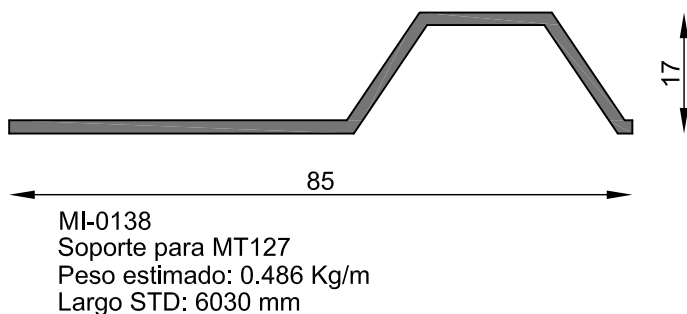
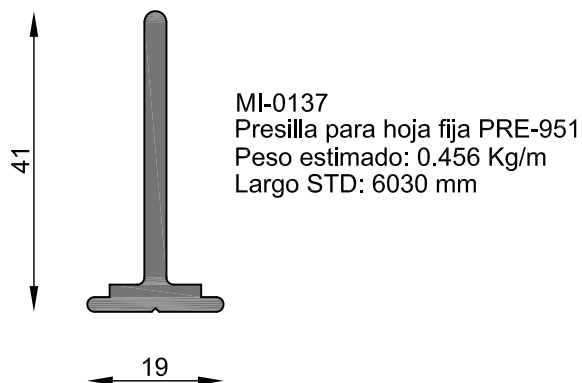
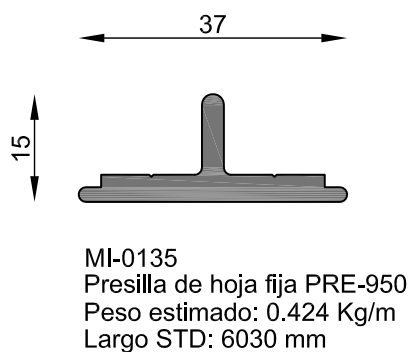

Esc 1:1

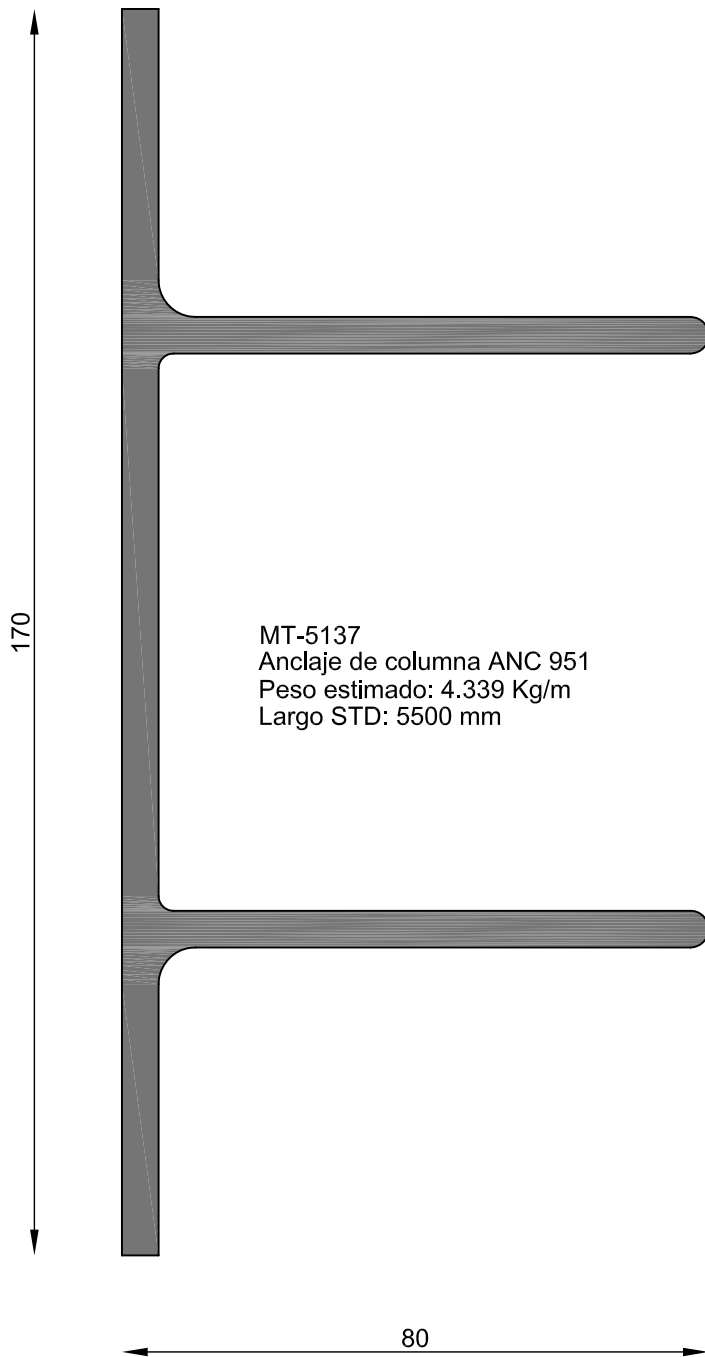

MT-5137  
Anclaje de columna ANC 951  
Peso estimado: 4.339 Kg/m  
Largo STD: 5500 mm

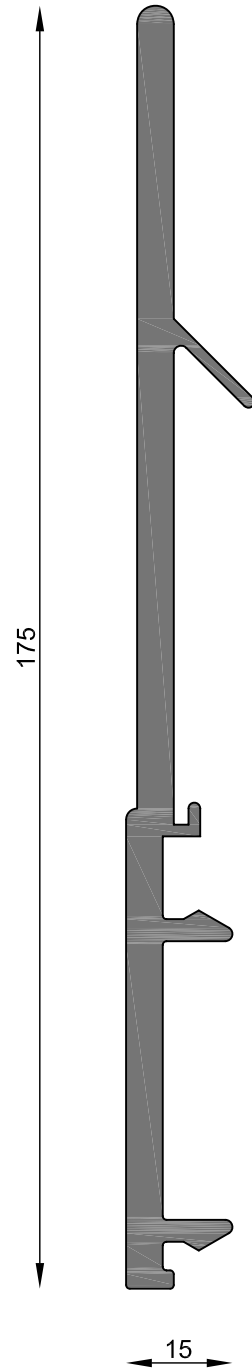

MT-5253  
Presilla de cielorraso PRE 954  
Peso estimado: 2.633 Kg/m  
Largo STD: 5500 mm

Esc 1:1

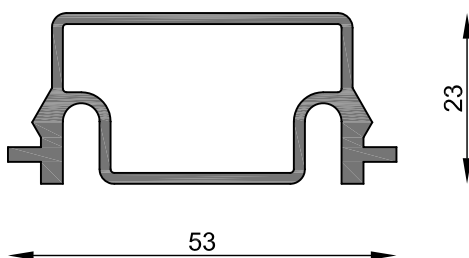

MT-5400  
 Presilla de revestimiento PRE 953  
 Peso estimado: 0.732 Kg/m  
 Largo STD: 6000 mm

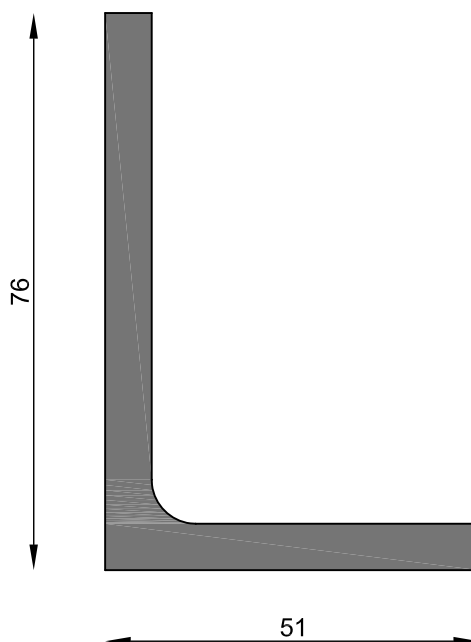

MT-5605  
 Anclaje inferior de columna ANC 964/966  
 Peso estimado: 2.087 Kg/m  
 Largo STD: 6030 mm

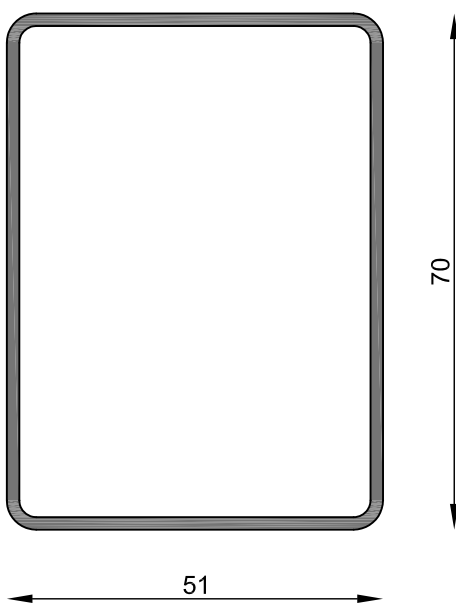

MT-5401  
 Empalme de columna LUV 974  
 Peso estimado: 1.061 Kg/m  
 Largo STD: 6000 mm

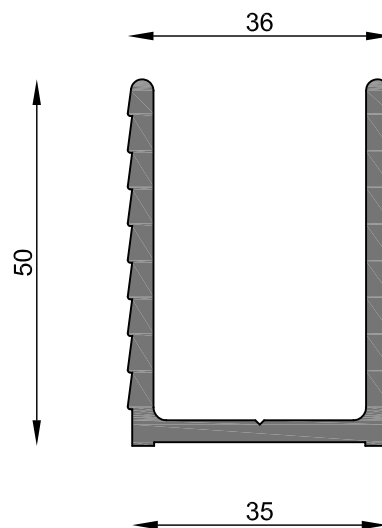

MT-2457  
 "U" de armado  
 Peso estimado: 1.094 Kg/m  
 Largo STD: 6030 mm

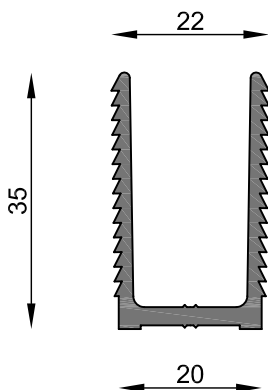

MT-0479  
 "U" de armado  
 Peso estimado: 0.489 Kg/m  
 Largo STD: 6030 mm

Esc 1:1

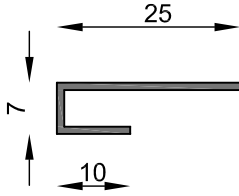

MT-1003  
 Perfil J 7 x 25 mm  
 Peso estimado: 0.108 Kg/m  
 Largo STD: 6030 mm

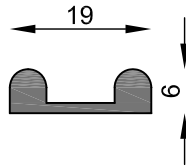

MT-1089  
 Riel vitrina  
 Peso estimado: 0.184 Kg/m  
 Largo STD: 6030 mm

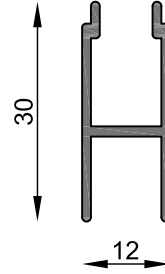

MT-1012  
 Umbral vitrina  
 Peso estimado: 0.240 Kg/m  
 Largo STD: 6030 mm

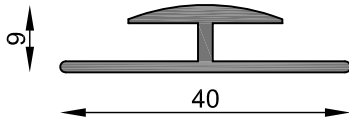

MT-1041  
 Varios  
 Peso estimado: 0.292 Kg/m  
 Largo STD: 6030 mm

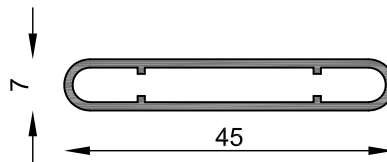

MT-0802  
 Tablilla celosia  
 Peso estimado: 0.302 Kg/m  
 Largo STD: 6030 mm

MT-1674  
 Dintel vitrina  
 Peso estimado: 0.184 Kg/m  
 Largo STD: 6030 mm

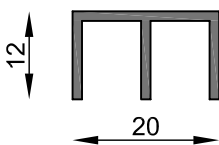

MT-2924  
 Guía techo corredizo  
 Peso estimado: 0.929 Kg/m  
 Largo STD: 6030 mm

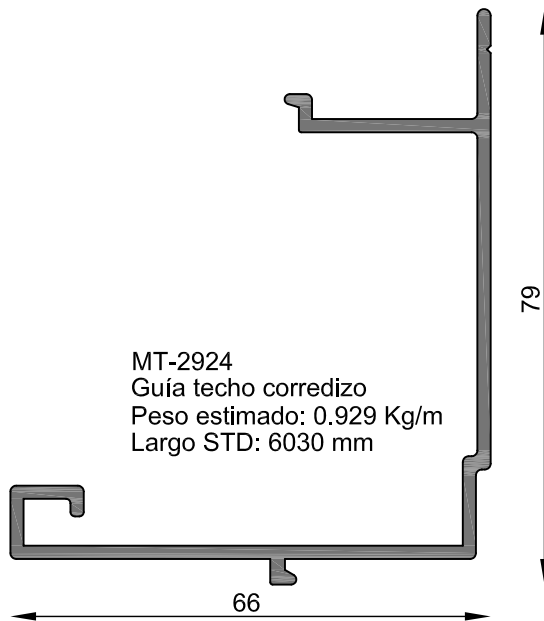

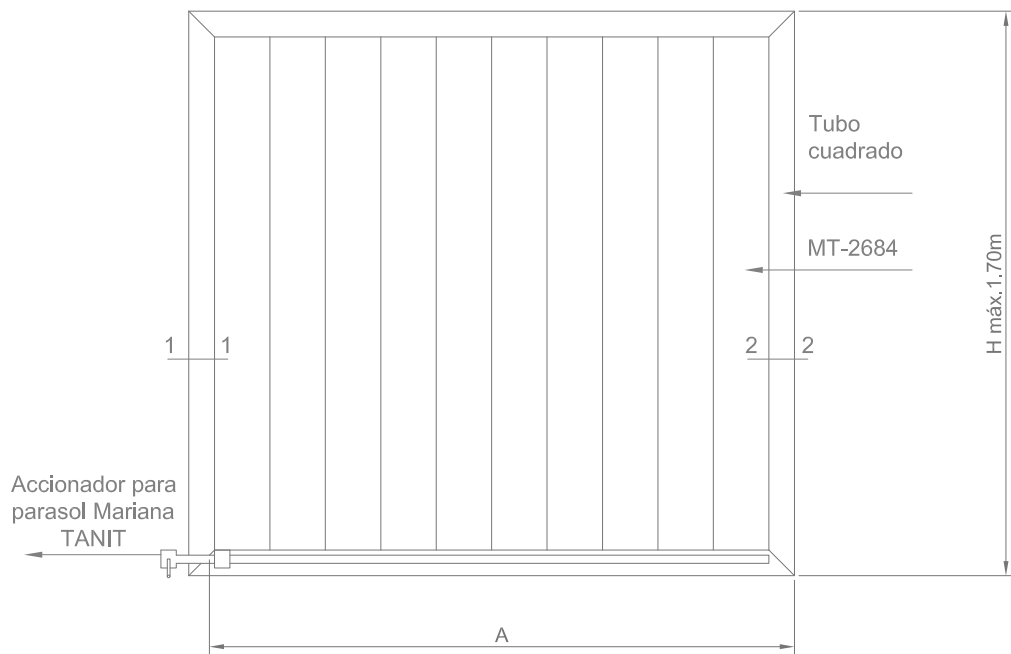
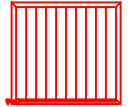

CORTE 1-1

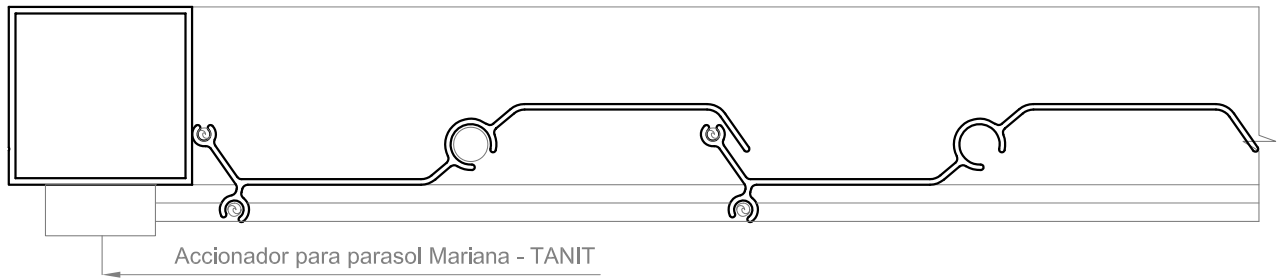

CORTE 2-2

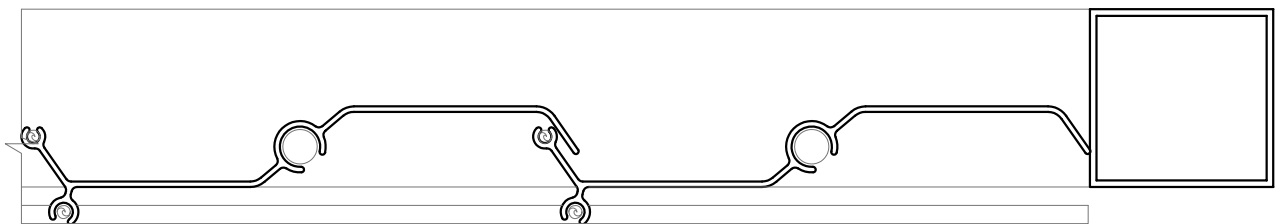

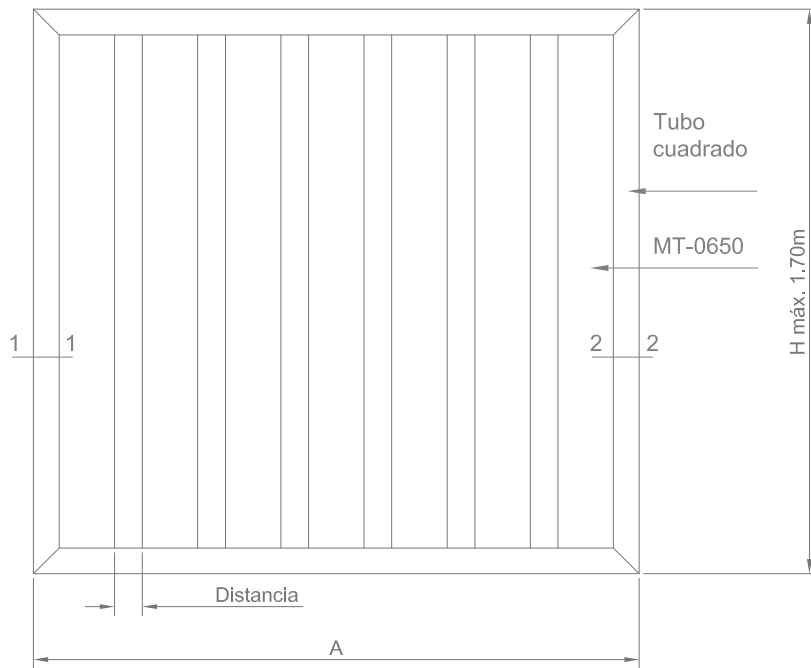
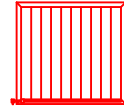

CORTE 1-1

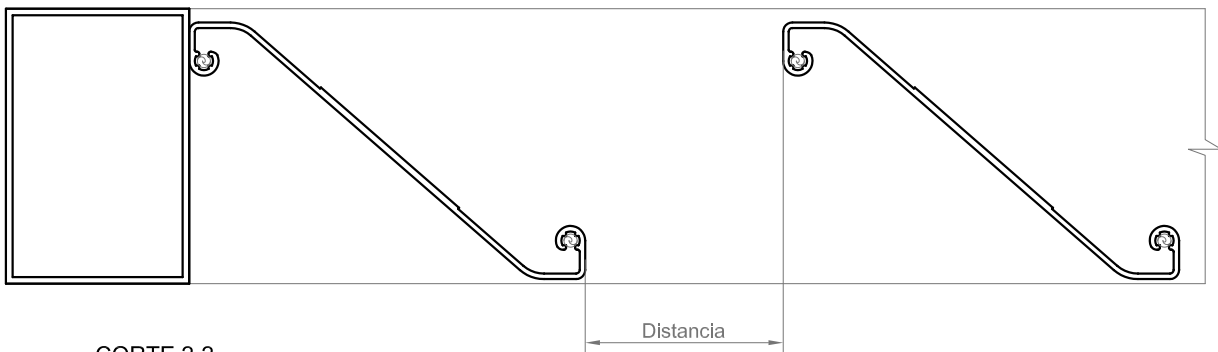

CORTE 2-2

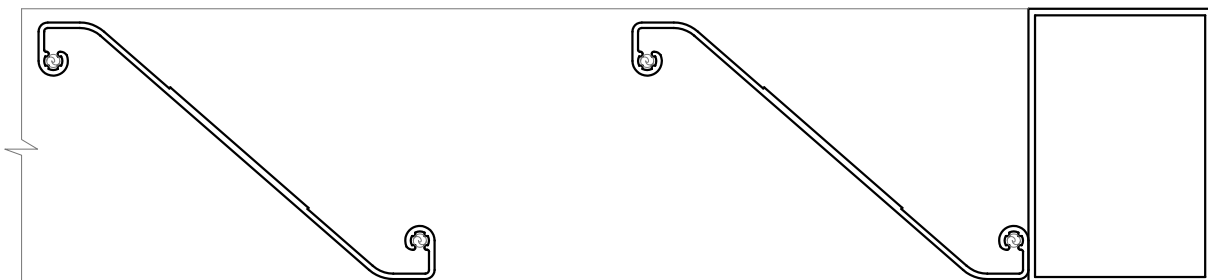



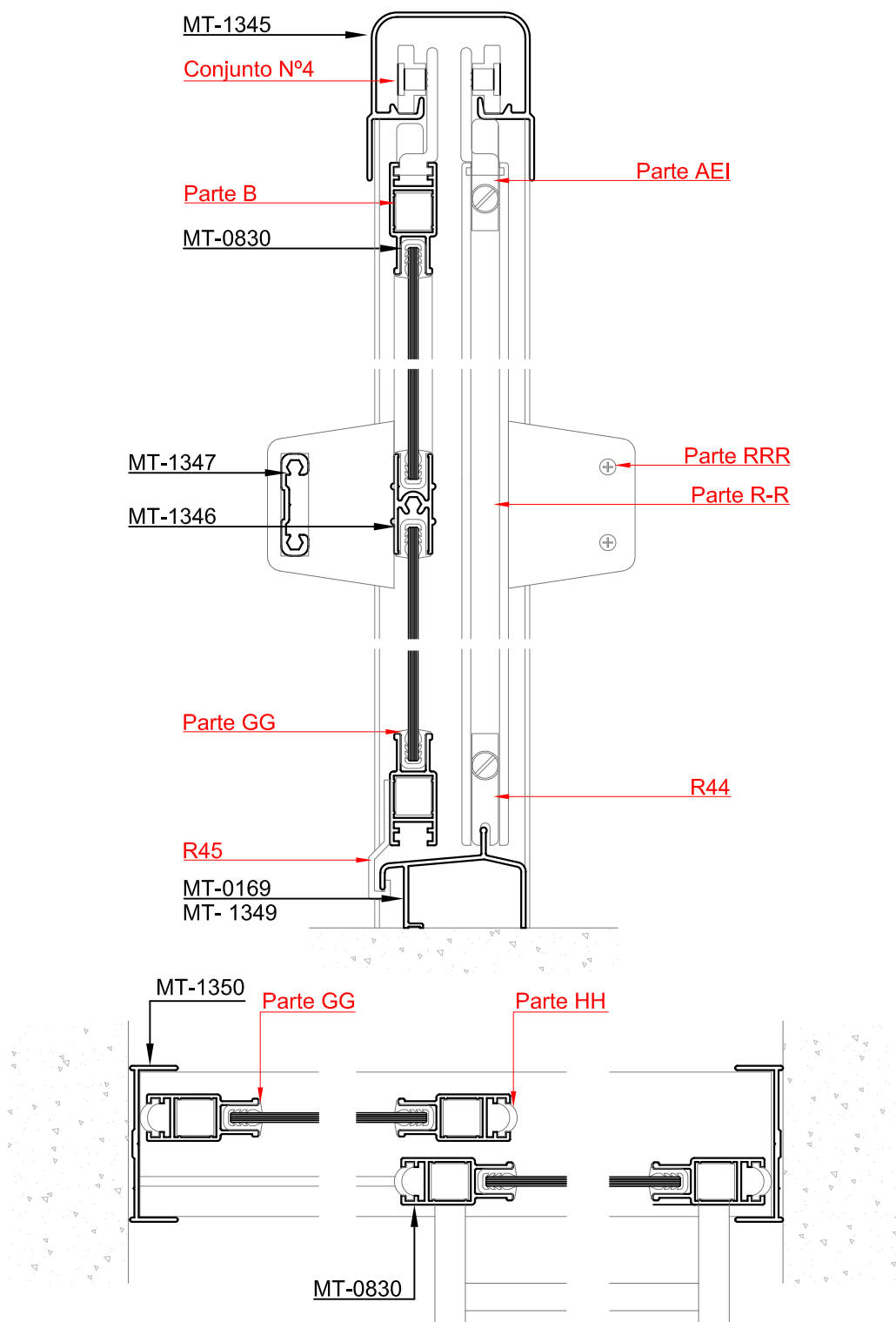
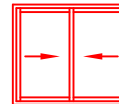

Dimensiones de corte de perfiles

Cantidad	Perfil N°	Denominación	Medida (mm)	Corte
2	MT-1950	Jambas de marco	H-34	90-90
1	MT-0169	Umbral de marco	A-6	90-90
1	MT-1345	Dintel de marco	A	90-90
4	MT-0830	Jambas de hoja	H-73	45-45
4	MT-0830	Zócalo y Cabezal de hoja	(A/2)+12	45-45

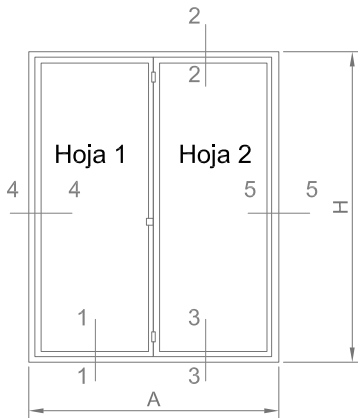

CORTE 2-2

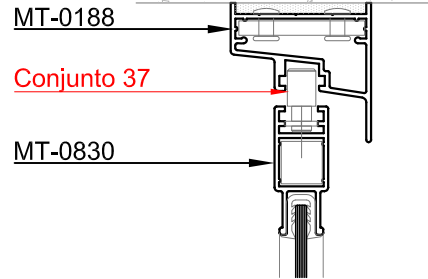

CORTE 1-1

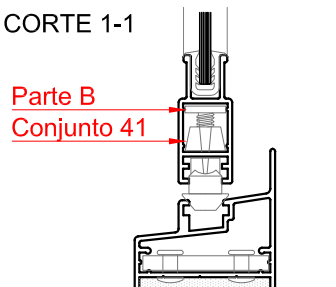

CORTE 3-3

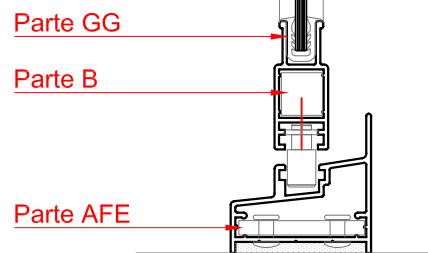

CORTE 4-4

HOJA 1

HOJA 2

CORTE 5-5

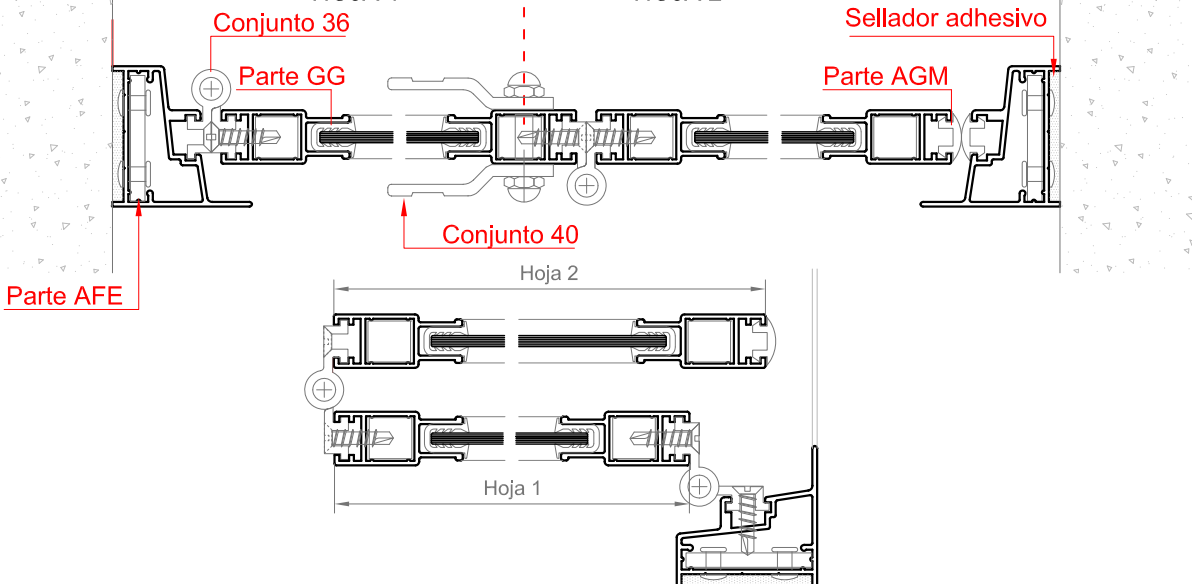

Dimensiones de corte de perfiles

Cantidad	Perfil N°	Denominación	Medida (mm)	Corte
2	MT-0188	Jambas de marco	H	45-45
2	MT-0188	Umbral y dintel de marco	A	45-45
4	MT-0830	Jambas de hoja	H-58	45-45
2	MT-0830	Zócalo y Cabezal de hoja (Hoja 1)	(A/2)-43	45-45
2	MT-0830	Zócalo y Cabezal de hoja (Hoja 2)	(A/2)-20	45-45

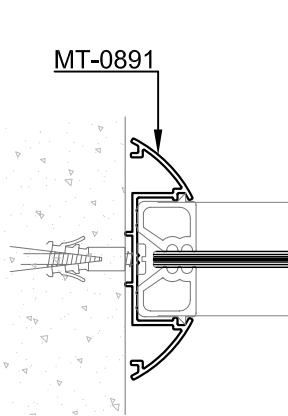
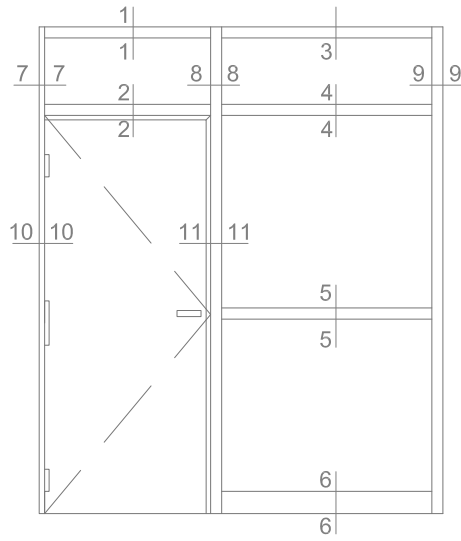
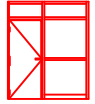

Corte 7-7

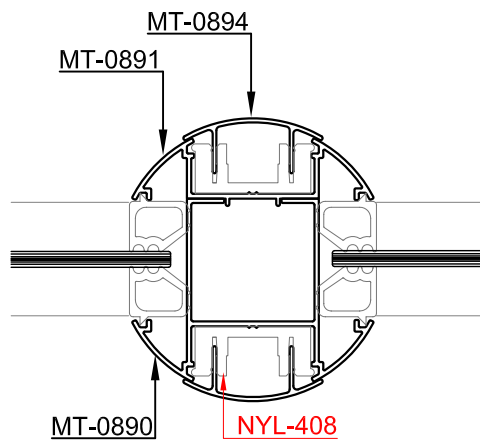

Corte 8-8

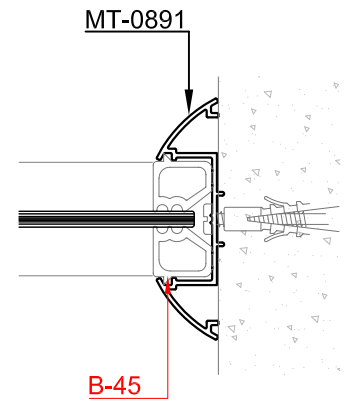

Corte 9-9

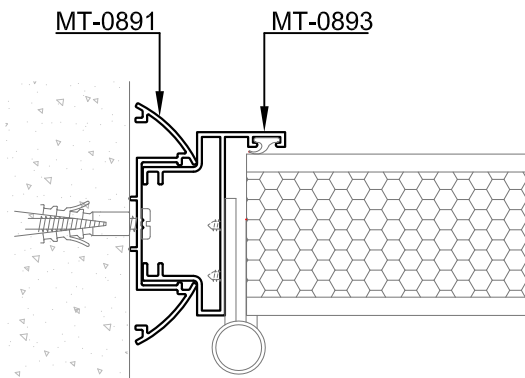

Corte 10-10

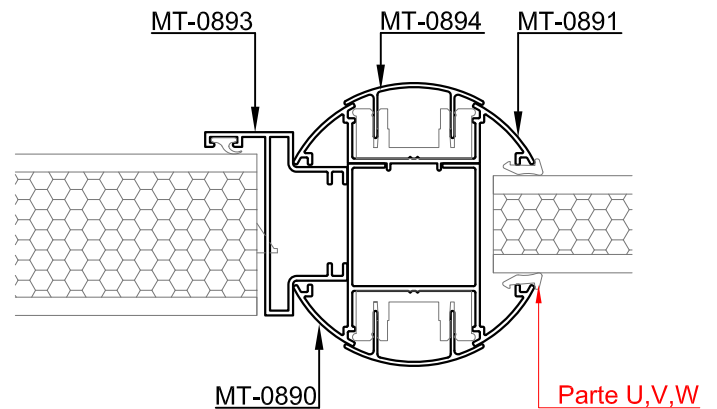

Corte 11-11

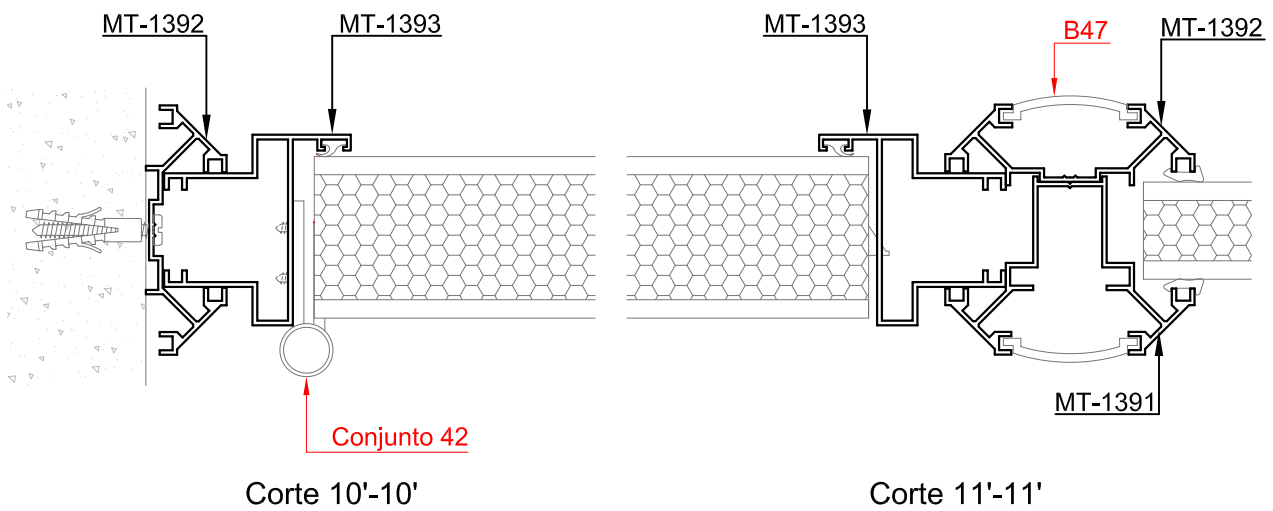
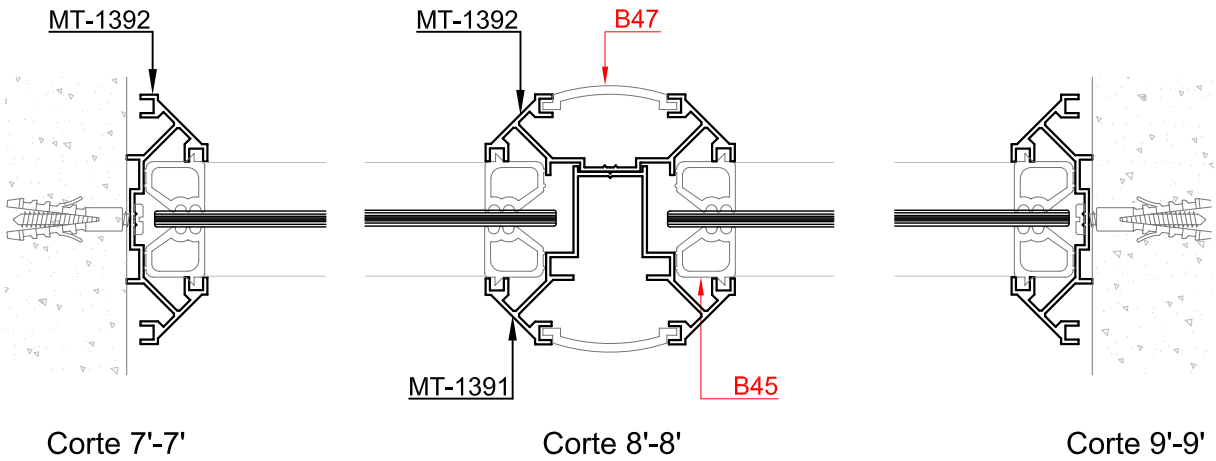
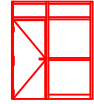

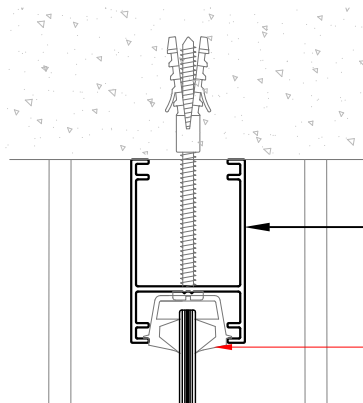
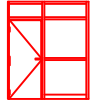

MT-0892

Corte 1-1

B46

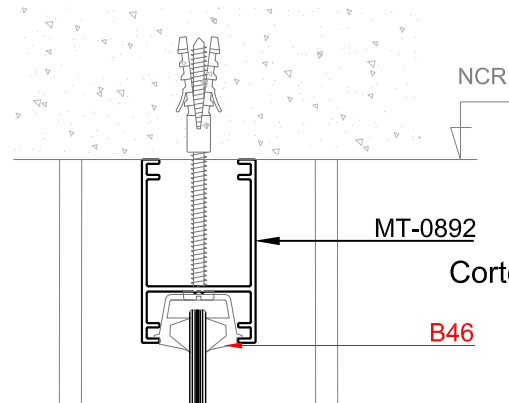

NCR

MT-0892

Corte 3-3

B46

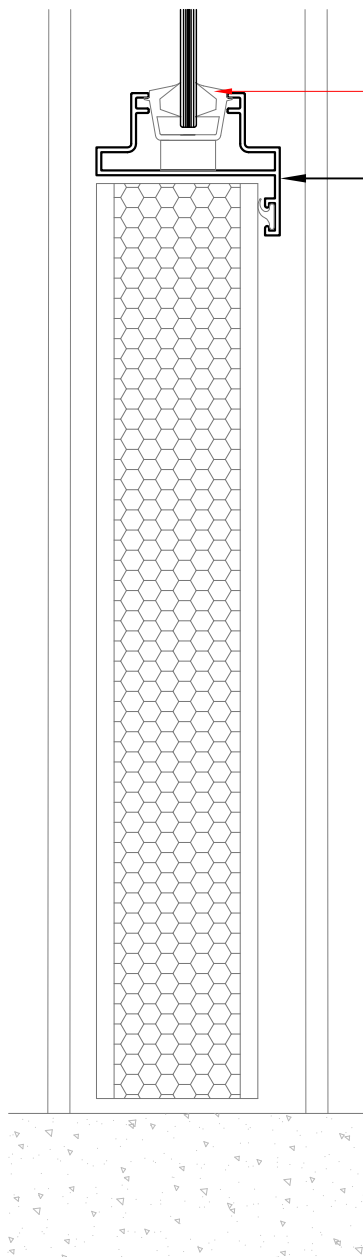

B46

MT-0893

Corte 2-2

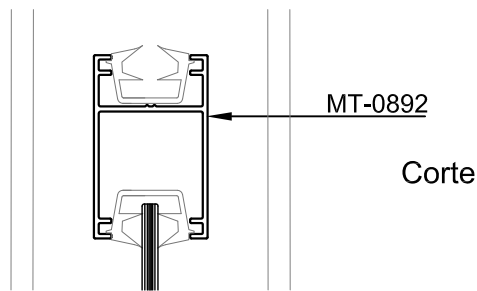

MT-0892

Corte 4-4

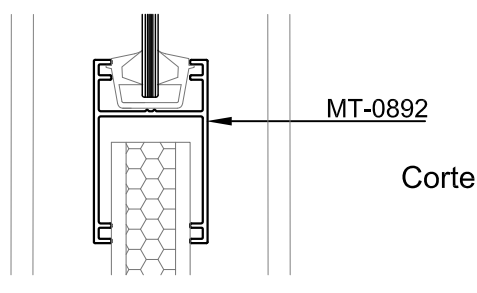

MT-0892

Corte 5-5

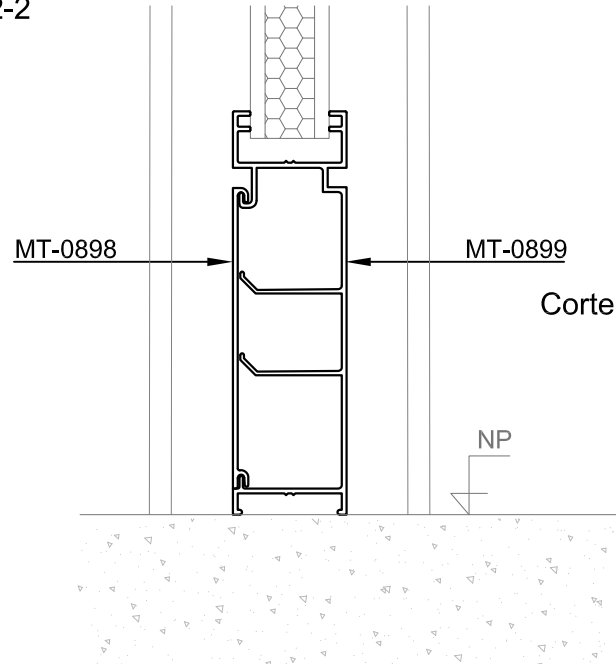

MT-0898

MT-0899

Corte 6-6

NP

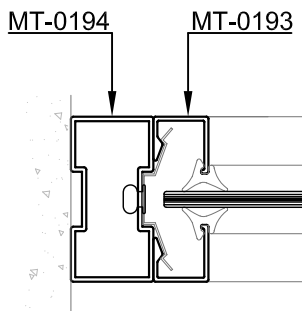
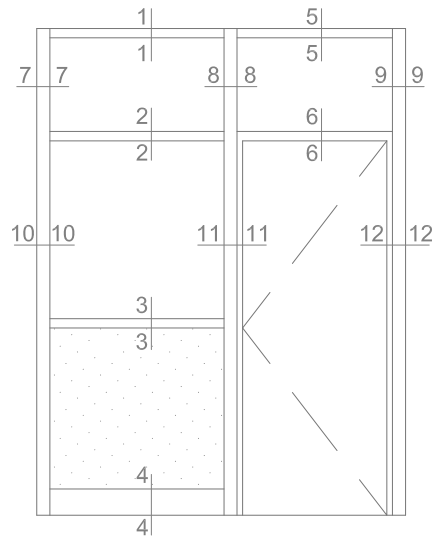
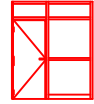

Corte 7-7

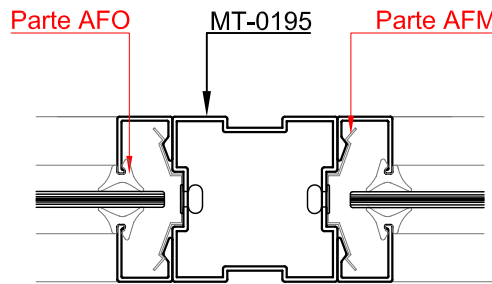

Corte 8-8

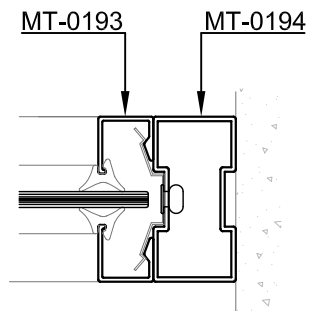

Corte 9-9

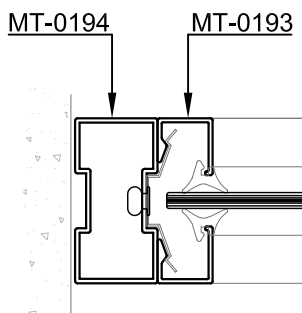

Corte 10-10

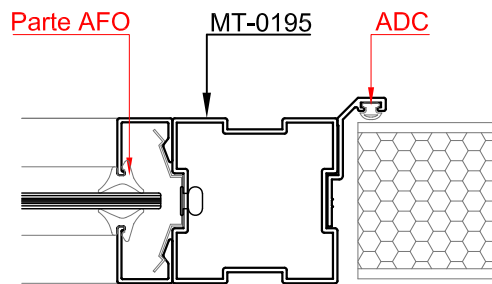

Corte 11-11

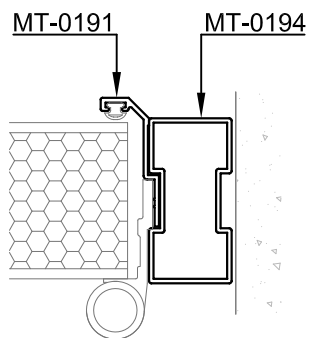

Corte 12-12

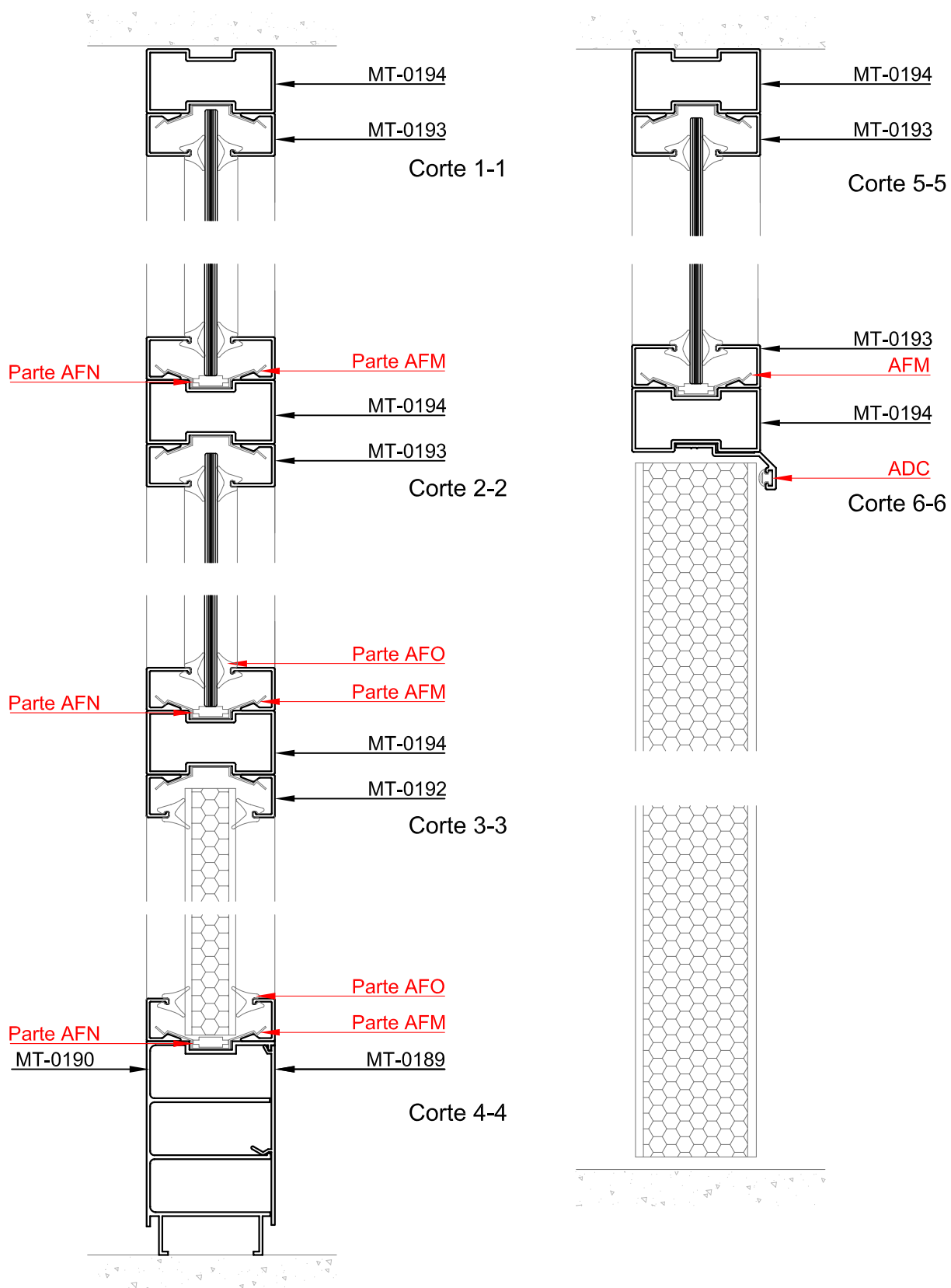
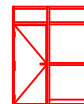

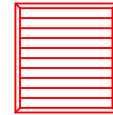

Conjunto vigente:

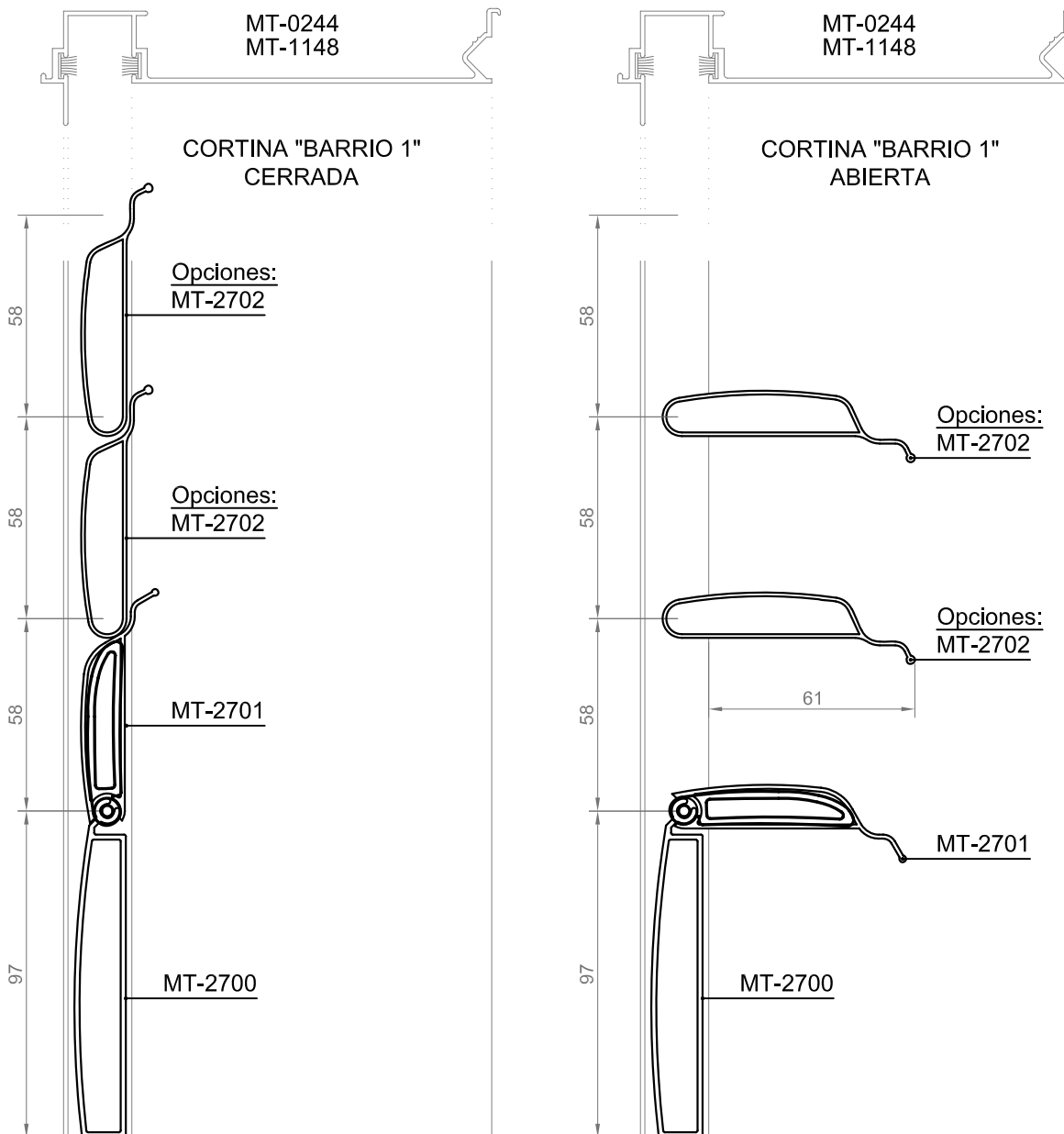

Perfil	Corte horizontal	Cantidad en altura
MT-2702	A-49mm	18 tablillas/m + 2
MT-2701	A-49mm	1 tablilla
MT-2700	A-20mm	1 tablilla

Accesorio: Kit costanero para cortina barrio







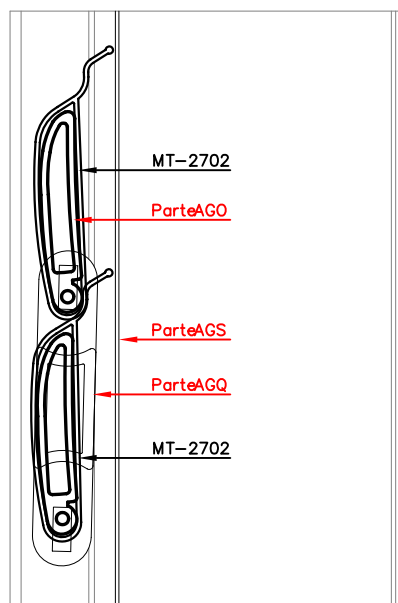
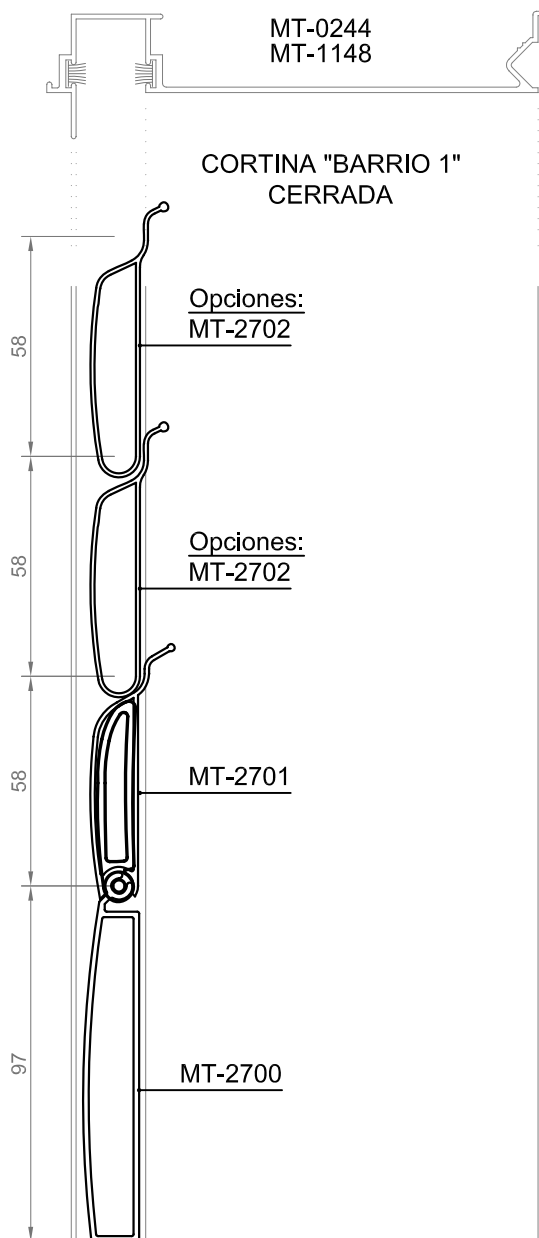



Conjunto vigente:

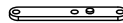

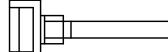
Accesorios

-  AGQ Eslabón costanero plástico
-  AGR Clavo para eslabón
-  AGQ Eslabón costanero metálico
-  AGO Tapón lateral tablilla
-  AGU Hebilla terminal
-  AGS-58 Fleje con ganchos paso 58mm
-  AGT Burlete cubre fleje

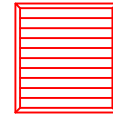

Conjunto vigente:

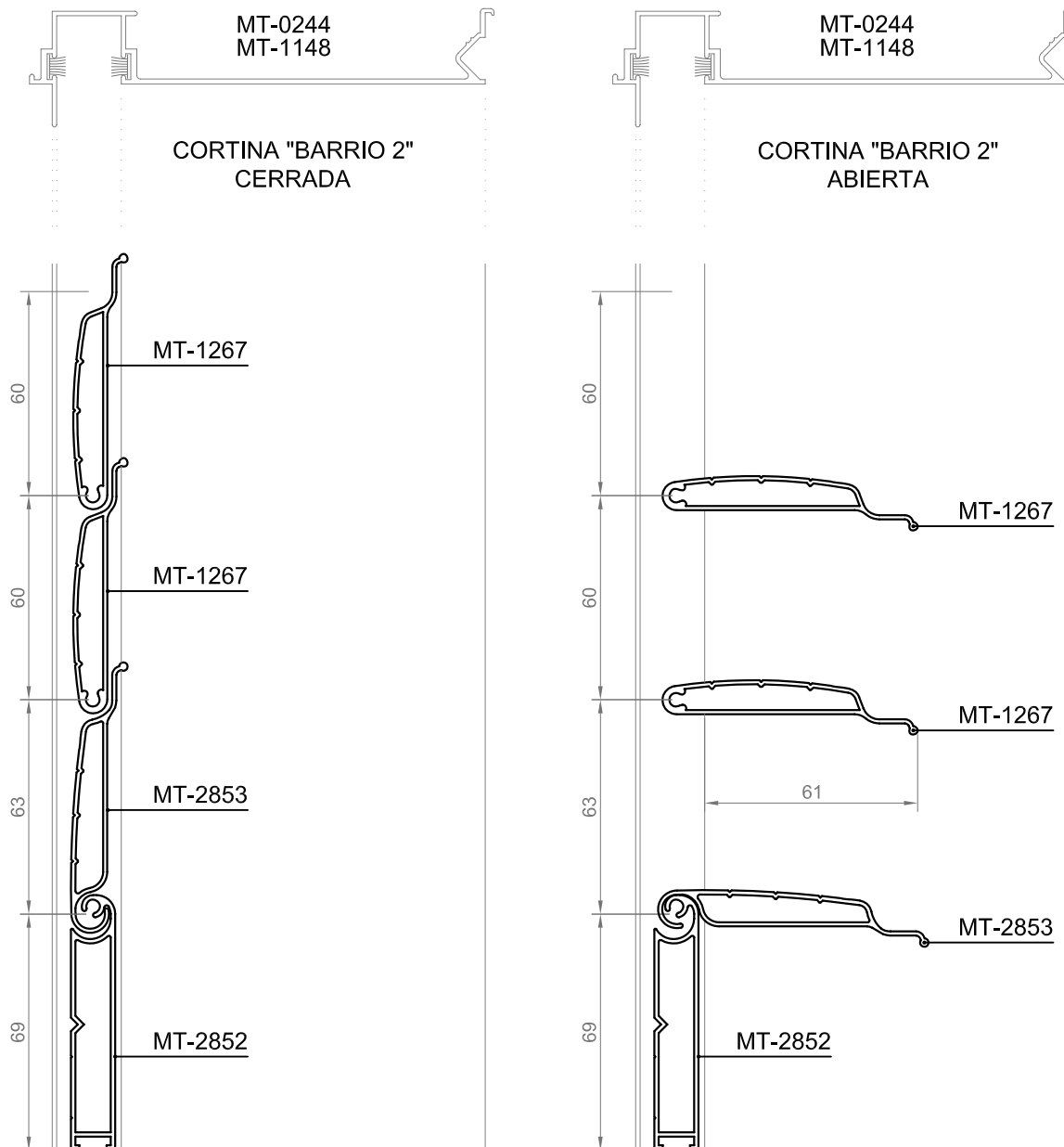

Perfil	Corte horizontal	Cantidad en altura
MT-1267	A-49mm	18 tablillas/m + 2
MT-2853	A-49mm	1 tablilla
MT-2852	A-20mm	1 tablilla

Accesorio: Kit costanero para cortina barrio Alcoa



Conjunto vigente:

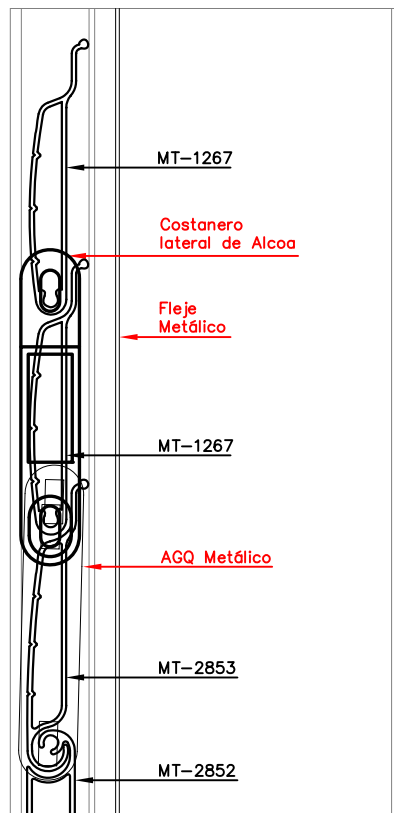
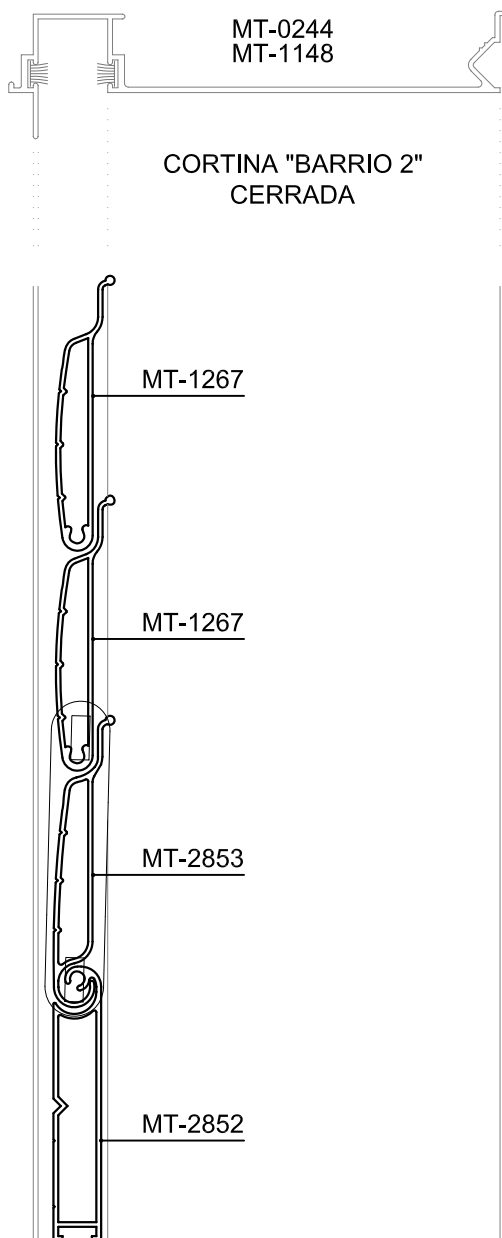

Accesorios



Costanero lateral de Alcoa



Clavo Alcoa

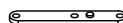

AGQ Eslabón costanero metálico

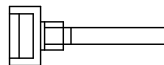

AGU Hebilla terminal



AGS-60 Fleje con ganchos paso 60mm



AGT Burlete cubre fleje

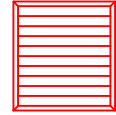

Detalle con guía para cortina barrio en "sistema Clásica".

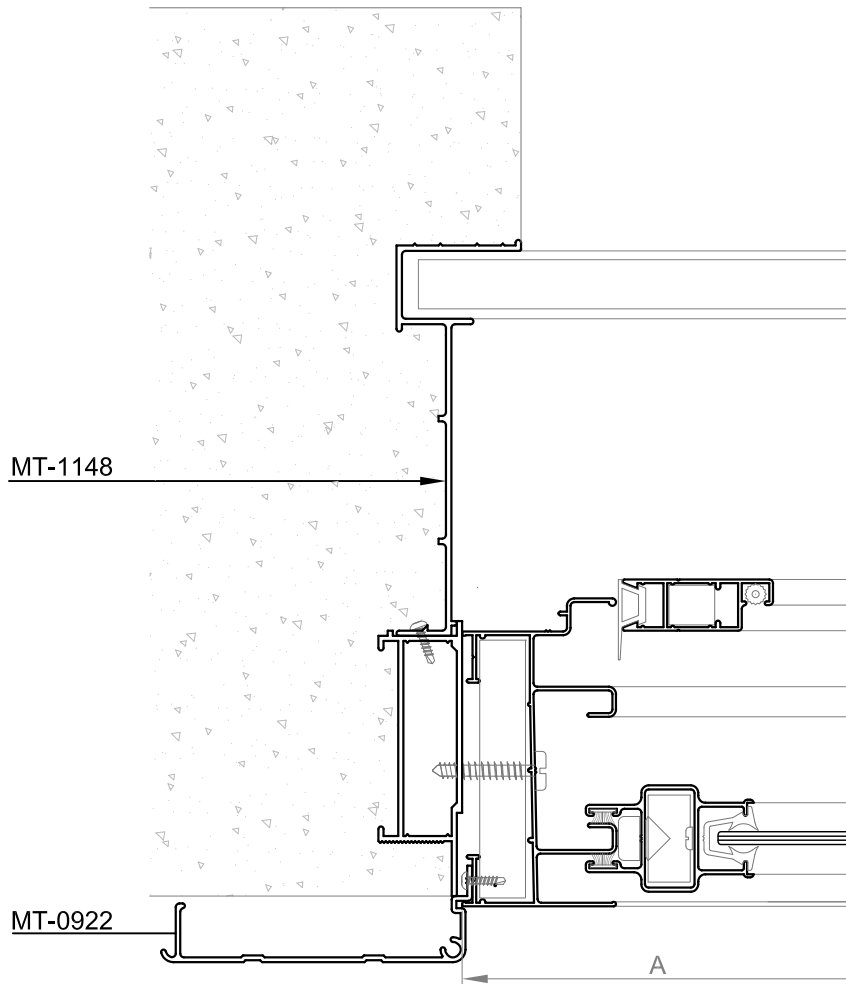



Detalle con guía para cortina barrio en "Sistema Actual".

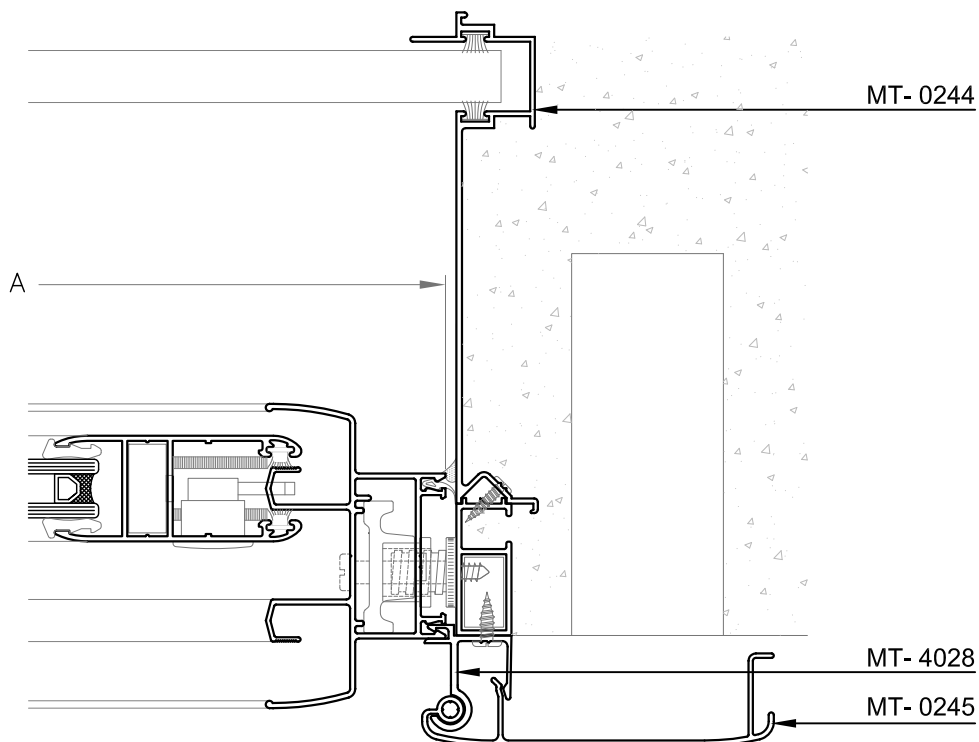

Opción con guía de cortina barrio en "Sistema MASS R60"

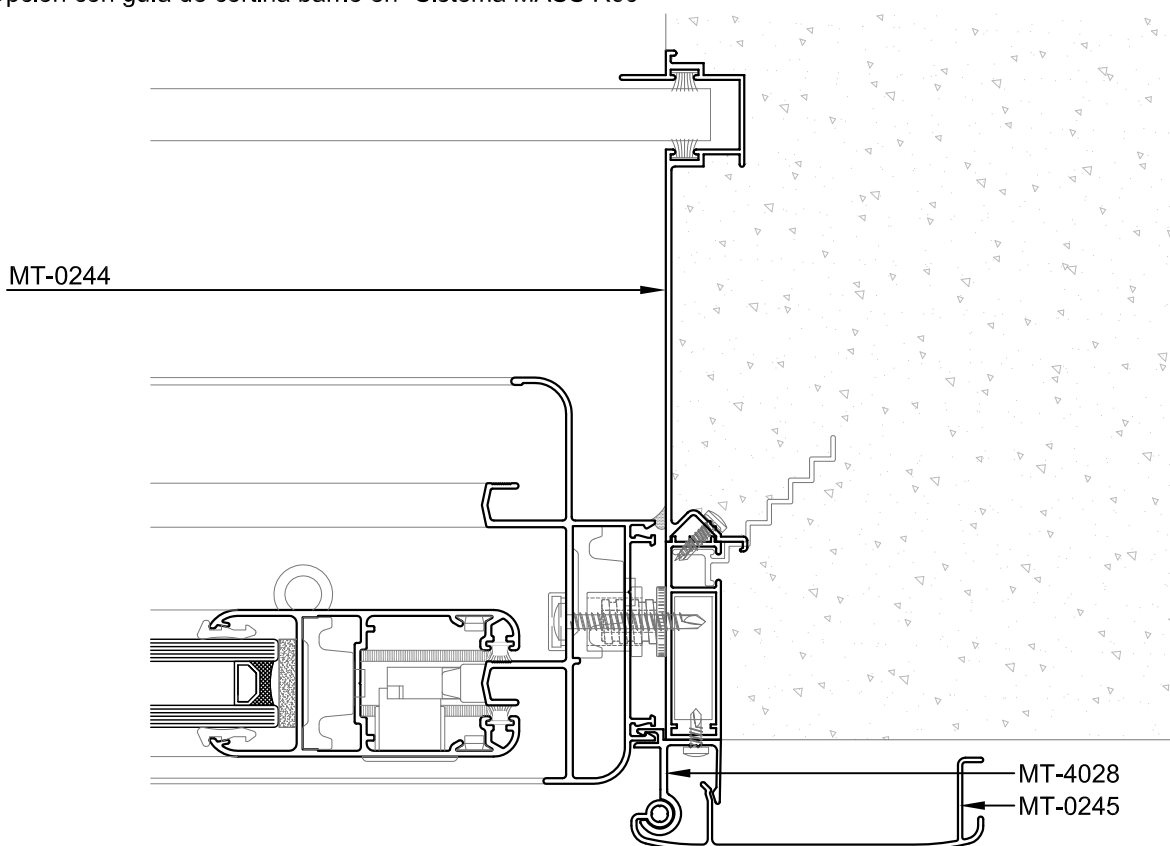

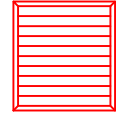

MT-0920

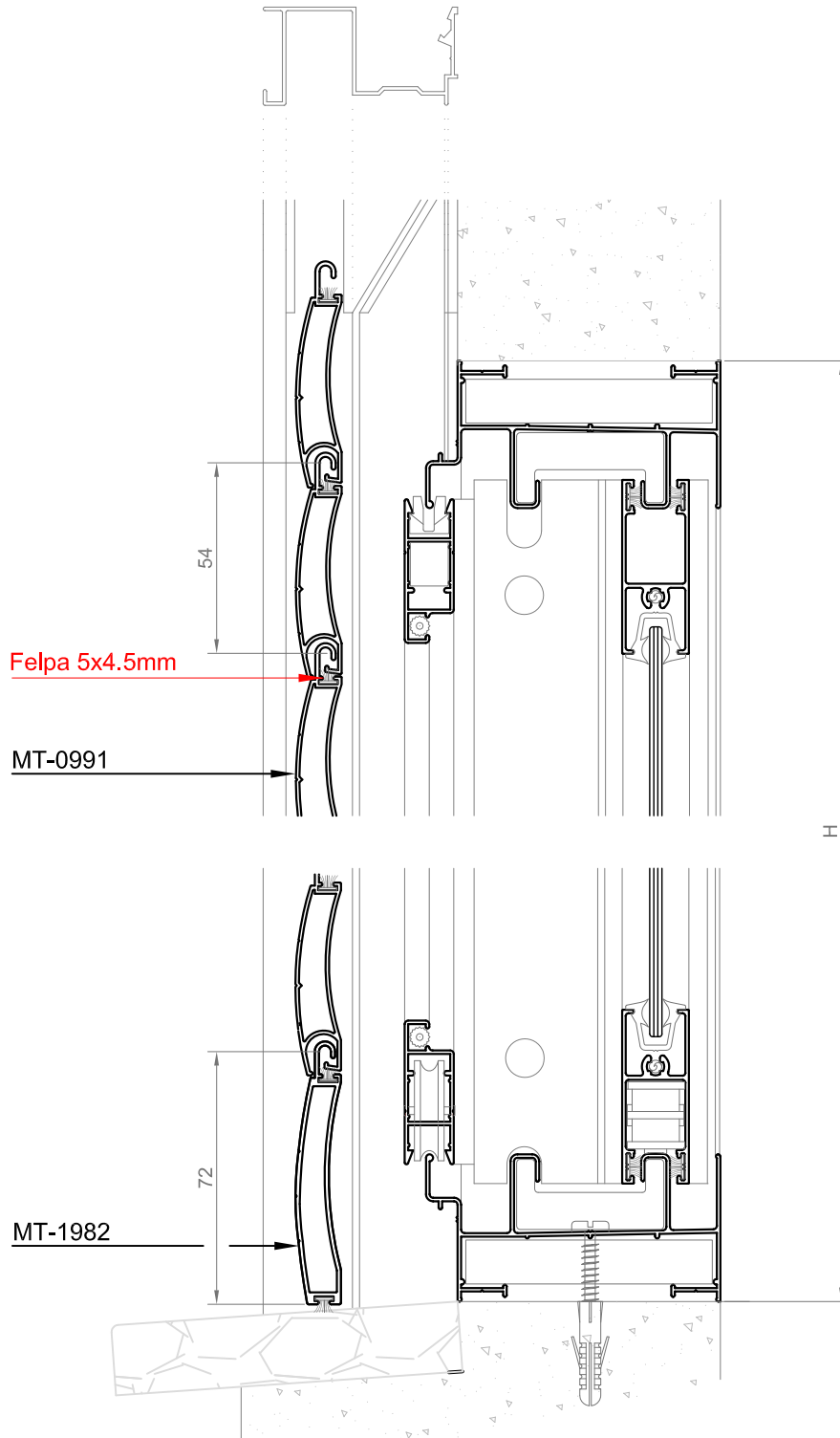

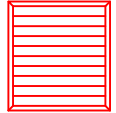

Detalle con guía para cortina común en "Sistema Clásica".

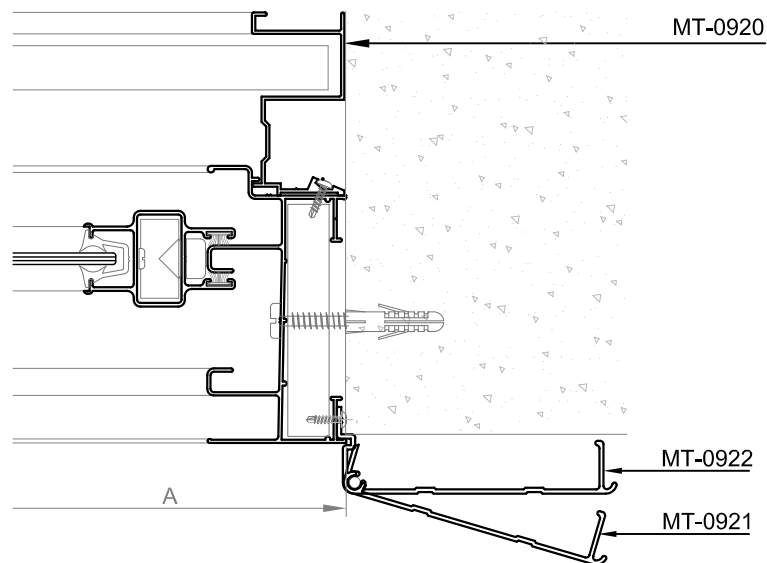

Detalle con guía para cortina común en "Sistema Actual".

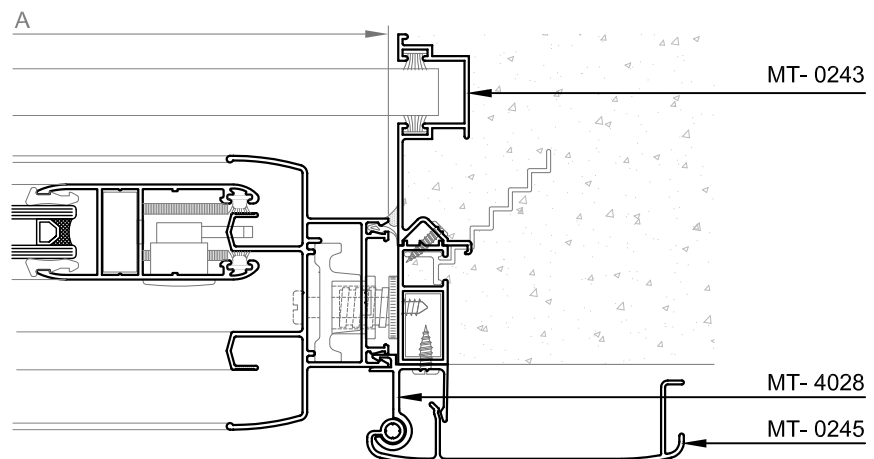

Detalle con guía para cortina común en "MASS R60".

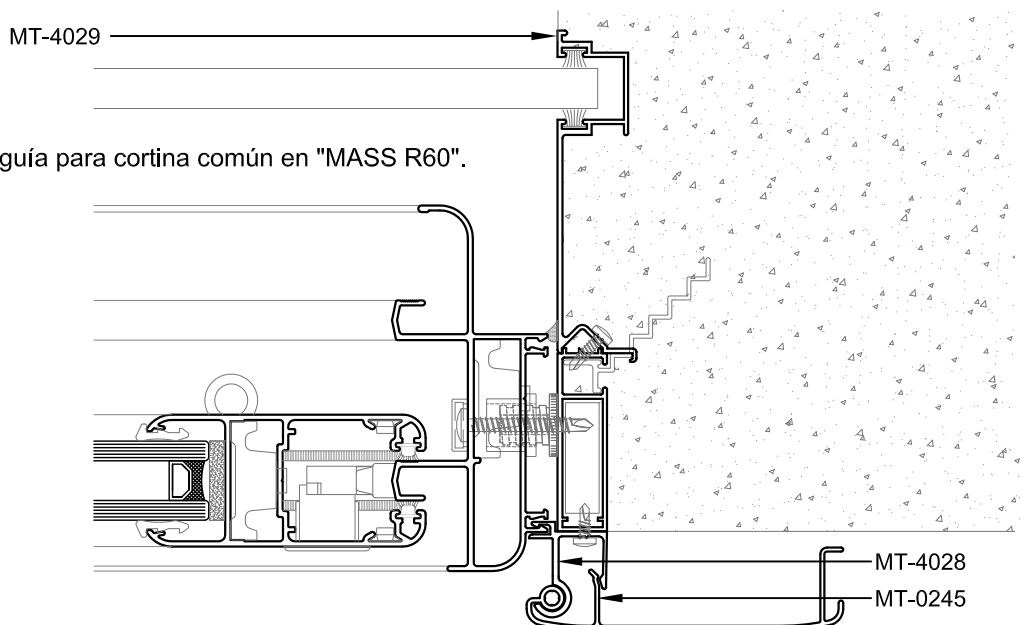

Todas las secciones de perfiles, conjuntos armados, ensambles, mecanizados, accesorios y forma de montaje que se muestran en el presente catálogo, corresponden al estado actual de los productos que han sido definidos en forma sencilla y clara.

El carpintero debe verificar, en cada caso, si las propuestas corresponden o son aplicables en los distintos casos que se presentan, ya que las posibilidades que se encuentran en la práctica no pueden estar todas representadas en un catálogo.

Todos los datos mencionados en el presente catálogo son indicativos y no comprometen a MDT.

En ningún caso MDT. se hará responsable por las deficiencias constructivas en las aberturas y/o cerramientos armados con sus perfiles.

La representación de la fijación en la obra es sólo indicativa, una sugerencia de como puede resolverse en forma adecuada y correcta la instalación de las aberturas, y siempre se recomienda utilizar premarcos en todo tipo de obra.

MDT aconseja la construcción de una muestra en escala natural de la abertura junto a su premarco, antes de comenzar una fabricación en cantidad.

Las dimensiones de corte indicadas en las tablas de descuentos son exactas, en todos los casos deberá el carpintero adoptar las mismas a la precisión de sus equipos.

Las escalas en este catálogo son de referencia, ya que las mismas dependen del formato y del medio de impresión, y en algunos casos pueden no coincidir con las escalas expresadas.

Metales del Talar S.A. se reserva el derecho de modificar, incluir o excluir diseños de la línea sin previo aviso.

Metales del Talar S.A. no se hace responsable de los cálculos estructurales, los cuales deberán ser realizados por profesionales habilitados para tal fin y se deja aclarado que las responsabilidades y obligaciones emergentes que pudieran establecerse entre el estudio o comitente y el carpintero, serán asumidas única y exclusivamente por las partes de dicha relación, siendo MDT ajena a la misma

Todos los pesos indicados son estimados de acuerdo a la dimensión nominal del perfil y sus posibles variaciones en el peso, son el resultado de aplicar las tolerancias dimensionales según Norma IRAM 699. La empresa se reserva el derecho de modificar total o parcialmente, sin previo aviso, las especificaciones contenidas en este catálogo.

**Asistencia técnica:** [tecnica@metalesdeltalar.com](mailto:tecnica@metalesdeltalar.com)

Accesorios:

